



catalogo prodotti / product catalogue

*Nel futuro le porte probabilmente
si apriranno con il pensiero. Fino
ad allora, però, sogneranno sempre una
maniglia Linea Cali.*

index

indice collezioni / index collection	4
finiture / finishings	9
azienda / company	12
contemporary collections	24
classic collections	94
basic collections	156
vintage collections	172
crystal collections	242
accessori / accessories	288
accessori per mobile / furniture accessories	356
materiale pubblicitario / advertising material	364
istruzioni / instruction	369

legenda / legend

































rosetta ribassata / reduced rose

































sistema SmartBlock / SmartBlock system

indice





























contemporaneo / contemporary



























COLLEZIONE / COLLECTION	PAG.	COLLEZIONE / COLLECTION	PAG.	COLLEZIONE / COLLECTION	PAG.
 Ala cod. 1385	26	 Jet cod. 1425	52	 Slim cod. 1110	76
 Aqua cod. 1440	28	 Kendo cod. 1516	54	 Slim Pelle	78
 Brera	30	 Komfort cod. 1455	56	 Spirit cod. 1450	80
 Duna cod. 1410	32	 Nau cod. 1548	58	 Strip cod. 1660	82
 Dynamic cod. 1654	34	 Open cod. 1105	60	 Thais cod. 1155	84
 Elios cod. 1341	36	 Point cod. 1595	64	 Wind cod. 1655	86
 Elle cod. 1050	38	 Prisma cod. 1280	66	 Zen cod. 1156	88
 Elle Pelle	42	 Riflesso cod. 1360	68	 Zen Fusion cod. 1585	90
 ERA cod. 1600	44	 Rombo cod. 1420	70	 Zen Wengé cod. 1158	92
 Fish cod. 692	48	 Sintesi cod. 1300	72		
 Ibis cod. 691	50	 Sintesi Wengé cod. 1304	74		

classico / classic

COLLEZIONE / COLLECTION	PAG.	COLLEZIONE / COLLECTION	PAG.	COLLEZIONE / COLLECTION	PAG.
 Aldar cod. 920	96	 Heidi cod. 1665	122	 Relax	146
 Aria cod. 1630	98	 Karina cod. 940	124	 Rose cod. 996	148
 Beta cod. 488	100	 Kuba cod. 930	126	 Tess cod. 511	152
 Dafne cod. 509	102	 Kuba Pomolo cod. 936	128	 Tosca cod. 745	154
 Dalia	104	 Lady cod. 1390	130	 Trendy cod. 980	156
 Delfino cod. 955	108	 Libera cod. 981	132	<h2>basic</h2>	
 Elika cod. 990	112	 Marina cod. 755	134		
 Erica	114	 Moma	136	 Garda cod. 670	162
 Flavia	116	 Nota cod. 1330	138	 Ibiza cod. 545	166
 Firenze cod. 1460	118	 Pin-up cod. 925	140	 Mare cod. 710	168
 Havana cod. 1080	120	 Profilo cod. 1040	142	 Onda cod. 530	170
				 Piuma cod. 1415	172

vintage

COLLEZIONE / COLLECTION	PAG.	COLLEZIONE / COLLECTION	PAG.	COLLEZIONE / COLLECTION	PAG.
 Aida	176	 Glamor cod. 1555	200	 Rococò cod. 1285	230
 Aisha	178	 Jardin cod. 1560	202	 Sissi cod. 1400	232
 Arcadia cod. 1640	180	 Liberty cod. 1160	206	 Soleil cod. 1325	234
 Arte cod. 1165	182	 Nature cod. 1320	210	 Tiffany cod. 1308	236
 Barocco cod. 1520	184	 Ninfa cod. 1540	212	 Tiffany Mesh cod. 1307	238
 Brilliant Crystal cod. 1526	186	 Ninfa Crystal cod. 1542	214	 Tiffany Vetro	240
 Brilliant Diamond cod. 1525	188	 Ninfa Porcellana cod. 1546	216	 Zaara cod. 1535	242
 Charme cod. 1590	190	 Opera cod. 1055	218		
 Daisy cod. 1070	194	 Opera Crystal cod. 1056	222		
 Epoca cod. 1210	196	 Poesia cod. 1395	224		
 Frida cod. 1700	198	 Queen cod. 1406	228		

COLLEZIONE / COLLECTION	PAG.	COLLEZIONE / COLLECTION	PAG.	COLLEZIONE / COLLECTION	PAG.
 Brilliant Crystal cod. 1526	186	 Luce	264	 Spirit Mesh cod. 1451	282
 Brilliant Diamond cod. 1525	188	 Nau Crystal cod. 1549	266	 Tiffany Mesh cod. 1307	236
 Cosmic cod. 1335	246	 Ninfa Crystal cod. 1542	214	 Veronica cod. 900	284
 Crystal cod. 830	248	 Opera Crystal cod. 1056	220	 Zen Mesh cod. 1157	286
 Diamante cod. 905	250	 Point Crystal cod. 1596	268		
 Elika Crystal cod. 991	252	 Profilo Mesh cod. 1041	270		
 Elios Crystal	254	 Reflex cod. 1215	272		
 Fish Crystal cod. 700	256	 Riflesso Mesh	274		
 Gemma	258	 Riflesso Rocks	276		
 Havana Mesh cod. 1090	260	 Shell Mesh cod. 694	278		
 Idea Crystal cod. 871	262	 Sintesi Mesh cod. 1301	280		

collezioni / collections

COLLEZIONE / COLLECTION	COD.	PAG.	COLLEZIONE / COLLECTION	COD.	PAG.	COLLEZIONE / COLLECTION	COD.	PAG.
Aida	-	176	Glamor	1555	198	Queen	1406	220
Aisha	-	174	Havana	1080	120	Reflex	1215	270
Ala	1385	26	Havana Mesh	1090	258	Relax	-	144
Aldar	920	96	Heidi	-	122	Riflesso	1360	68
Aqua	1440	28	Ibis	691	48	Riflesso Mesh	-	272
Arcadia	1640	178	Ibiza	545	164	Riflesso rocks	-	274
Aria	1630	98	Idea Crystal	871	260	Rococò	1285	228
Arte	1165	180	Jardin	1560	200	Rombo	1420	70
Barocco	1520	182	Jet	1425	50	Rose	996	144
Beta	488	100	Karina	940	122	Shell Mesh	694	274
Brera	-	30	Kendo	1516	52	Sintesi	1300	72
Brilliant Crystal	1526	184	Komfort	1455	54	Sintesi Mesh	1301	278
Brilliant diamond	1525	186	Kuba	930	124	Sintesi wengé	1304	74
Brixia	760	158	Kuba Pomolo	936	126	Sissi	1400	228
Charme	1590	188	Lady	1390	128	Slim	1110	76
Cosmic	1335	244	Libera	981	130	Slim Pelle	-	78
Crystal	830	246	Liberty	1160	202	Soleil	1325	230
Dafne	509	102	Luce	-	262	Spirit	1450	80
Daisy	1070	190	Mare	710	166	Spirit Mesh	1451	280
Dalia	-	104	Marina	755	132	Strip	1660	82
Delfino	955	108	Moma	-	134	Tess	511	148
Diamante	905	248	Nature	1320	208	Thais	1155	84
Duna	1410	32	Nau	1548	58	Tiffany	1308	234
Dynamic	1654	36	Nau Crystal	1549	264	Tiffany Mesh	1307	236
Elika	990	112	Ninfa	1540	210	Tiffany Vetro	-	238
Elika Crystal	991	248	Ninfa Crystal	1542	202	Tosca	745	152
Elios	1341	34	Ninfa Porcellana	1546	214	Trendy	980	154
Elios Crystal	-	252	Nota	1330	136	Veronica	900	282
Elle	1050	36	Onda	530	168	Wind	1655	86
Elle Pelle	-	40	Open	1105	60	Zaara	1535	240
Epoca	1210	194	Opera	1055	216	Zen	1156	88
Era	1600	42	Opera Crystal	1056	218	Zen Fusion	1585	90
Erica	-	114	Pin-up	925	138	Zen Mesh	1157	284
Fish	692	46	Piuma	1415	170	Zen Wengé	1158	92
Fish Crystal	700	254	Poesia	1395	222			
Flavia	-	116	Point	1595	64			
Florenzia	1460	118	Point Crystal	1596	264			
Frida	1700	196	Prisma	1280	66			
Garda	670	160	Profilo	1040	140			
Gemma	-	256	Profilo Mesh	1041	268			

accessori / accessories

COLLEZIONE / COLLECTION	PAG.	COLLEZIONE / COLLECTION	PAG.	COLLEZIONE / COLLECTION	PAG.
maniglioni / pull handles	292	fermaporta / door stop	340	placche incasso / inset handle kit	348
maniglioni alzanti / pull-up handles	316	campanelli / bells	341	serie hotel / hotel series	352
pomoli per porte / door knobs	319	catenacci / deadbolts	341	copricerniere / hinge covers	355
battenti / door knockers	330	cremonesi mp / window handles gratz mp	342	cerniere / hinges	356
bocchette / escutcheons	332	appendiabiti / coat hooks	343	pomelli per mobile / furniture knobs	358
bocchette set wc / privacy set	336	accessori per porte blindate / accessories for armored doors	344	maniglie per mobile / furniture handles	365
chiavi / keys	339				

finiture / finishings

AA argento antico opaco antique silver	CR cromo lucido polished chrome	OM oro + oro sabbato polished gold + matt gold mix
AC antracite satinato + cromo satin anthracite + polished chrome	CS cromo satinato satin chrome	OO ottone opaco matt brass
AF argento francese french silver	CZ cromo lucido + oro zecchino polished chrome + gold plated	OS ottone satinato satin brass
AG antracite satinato + oro zecchino satin anthracite + gold plated	FV ferro effetto invecchiato aged iron (brass)	OT ottone satinato + ottone lucido satin brass + polished brass mix
AM antracite satinato + patiné satin anthracite + patiné mat	MC cromo + cromo sabbato chrome + matt chrome mix	OZ oro zecchino gold plated
AN ottone invecchiato aged brass	MO oro + oro sabbato polished gold + matt gold mix	PM patiné patiné mat
AS antracite satinato satin anthracite	NF nero francese french black	PV titanio titanium
BA bianco lucido glossy white	NL nickel lucido polished nickel	TM peltro pewter
BM bronzo opaco matt bronze	NP bronzo opaco + patiné matt bronze + patiné mat	VB ottone vibrato vibrato brass
BO bronzo sfumato opaco bronze	NS nickel satinato satin nickel	VE nero opaco matt black
CC cromo satinato + cromo satin chrome + polished chrome mix	OB ottone bronzato satinato bronzed brass + satin brass mix	VN nero opaco + nero francese matt black + french black
CE nero opaco + cromo lucido matt black + polished chrome	OF oro francese french gold	ZC oro zecchino + cromo lucido gold plated + polished chrome
CM cromo + cromo sabbato chrome + matt chrome mix	OG ottone bronzato graffiato bronzed brass	ZO nero opaco + oro zecchino matt black + gold plated
CN nickel satinato + cromo satin nickel + polished chrome mix	OL ottone lucido verniciato polished brass	

finiture / finishings

CR cromo lucido
polished chrome



CS cromo satinato
satin chrome



CC cromo satinato+cromo
satin chrome+polished chrome



MC cromo+cromo sabbato
chrome+matt chrome mix



CN nickel satinato+cromo
satin nickel+polished chrome



AC antracite satinato+cromo
satin anthracite+polished chrome



AM antracite satinato+patiné
satin anthracite+patiné mat



AS antracite satinato
satin anthracite



AG antracite satinato+oro zecchino
satin anthracite+gold plated



ZO nero opaco+oro zecchino
matt black+gold plated



CE nero opaco+cromo lucido
matt black+polished chrome



VE nero opaco
matt black



NL nickel lucido
polished nickel



ZC oro zecchino+romo lucido
gold plated+polished chrome



OL ottone lucido verniciato
polished brass antique silver



OS ottone satinato
satin brass



OZ oro zecchino
gold plated



AA titanio
titanium



OM oro+oro sabbato
polished gold+matt gold



OT ottone satinato+ottone lucido
satin brass+polished brass



NS nickel satinato
satin nickel



OG ottone bronzato graffiato
bronzed brass



PM patiné
patiné mat



VB ottone vibrato
vibrato brass



OB ottone bronzato satinato
bronzed brass+satin brass



BM bronzo opaco
matt bronze



FV ferro effetto invecchiato
aged iron (brass)



AN ottone invecchiato
aged brass



AA argento antico opaco
antique silver



NF nero francese
french black



AF argento francese
french silver



TM peltro
 pewter



VN nero opaco+nero francese
matt black+french black



OO ottone opaco
matt brass



BO bronzo sfumato opaco
bronze



NP bronzo opaco + patiné
matt bronze + patiné mat



OF oro francese
french gold



Il fascino dello stile italiano si racconta nella nostra storia.

La differenza tra una maniglia e un semplice pezzo di ottone nasce nel 1986, quando Paolo e Danilo Cali, insieme a Mario Facchetti, fondarono la Linea Cali srl e iniziarono a trasformare delle semplici maniglie in ottone in complementi di arredo a tutti gli effetti.

Un'idea rischiosa ma lungimirante, che rivoluzionò il mondo della maniglieria e le permise di diventare una delle aziende di riferimento nella produzione di "maniglie di stile".

A oltre 30 anni dalla sua fondazione, Linea Cali continua a produrre in Italia seguendo la stessa filosofia, distinguendosi dalla concorrenza e rappresentando nel mondo il simbolo del lusso Made in Italy.

Ora l'azienda guarda al futuro con entusiasmo e fiducia, perché fino a quando le porte non si apriranno con il pensiero... sogneranno sempre una maniglia Linea Cali.

The difference between a handle and a simple piece of brass was born in 1986, when Paolo and Danilo Cali, together with Mario Facchetti, founded the Linea Cali srl and began to transform simple brass handles into furnishing accessories for all purposes.

A risky but far-sighted idea, which revolutionized the world of handles and allowed it to become one of the leading companies in the production of "style handles".

More than 30 years after its foundation, Linea Cali continues to produce in Italy following the same philosophy, distinguishing itself from the competition and representing the symbol of Made in Italy luxury in the world.

Now the company looks to the future with enthusiasm and trust, because as long as the doors will not be operated telepathically... they'll all still dream of a Linea Cali handle.





Produciamo maniglie di lusso impresiosite dagli inimitabili cristalli SWAROVSKI®.



Grazie alla pluriennale esperienza nel mondo del lusso, più di 30 anni fa Linea Cali percepì la necessità da parte dei clienti di possedere collezioni sempre più particolari ed esclusive. Iniziò così a trasformare oggetti di uso comune, le maniglie e i pomelli per mobile, in gioielli dalle mille sfaccettature impreziosendoli con cristalli Swarovski®.

Nati dalla passione per i dettagli e da un taglio di alta precisione, questi preziosi elementi infondono un fascino raffinato a ogni oggetto che impreziosiscono e si riconoscono dal sigillo "Crystals from Swarovski®", che funge da certificato di autenticità per i prodotti decorati con autentici cristalli Swarovski®.

Oggi, dopo oltre 25 anni dal lancio della prima collezione, le maniglie per porte e i pomelli per mobile Linea Cali risplendono con i cristalli Swarovski® negli ambienti più esclusivi e importanti rappresentando l'emblema del lusso più contemporaneo.

Linea Cali è fra le poche aziende al mondo a essere in possesso del certificato Swarovski® che le conferisce il titolo di Ingredient Branding Partners.

Thanks to our many years of experience in the world of luxury, over 30 years ago we sensed our clients' need to possess increasingly unique and exclusive collections. We thus started transforming everyday objects, handles and furniture knobs, into multifaceted jewels adorned with Swarovski® crystals.

Born out of a passion for detail and a high precision cut, these precious elements instil a refined appeal in each object that they adorn and are identified by the seal "Crystals from Swarovski®", that act as an authenticity certificate for the products decorated with authentic Swarovski® crystals.

Today, after over 25 years from the launch of the first collection, the Linea Cali door handles and furniture knobs shine brightly with Swarovski® crystals in the most exclusive and important locations representing the emblem of the most contemporary luxury.

Linea Cali is one of the few companies in the world to be in possession of the Swarovski® certificate which gives it the title of Ingredient Branding Partners.



SWAROVSKI

CERTIFICATE

Swarovski is the premium brand for the finest crystal embellishments since 1895. Available in a myriad of colors, effects, shapes and sizes, crystals from Swarovski offer designers a fabulous palette of inspiration.

LINEA CALI'

meets the standards set by Swarovski for its Ingredient Branding Partners and has therefore been approved as an Ingredient Branding Partner.

As provided in the Crystals from Swarovski Ingredient Brand Logo License Agreement, Ingredient Branding Partners are permitted to use the distinctive Swarovski seal depicted below on products, product packaging and in communication materials, for their products sold under the brand

LINEA CALI'

and embellished with 100% genuine Swarovski crystals.



The contract is based on a sustainable business relationship with Swarovski, on the agreement of defined standards and upon regular review.

Milan, April 11th 2019	April 10th 2020	
DATE AND PLACE OF ISSUE	EXPIRY DATE	SWAROVSKI

© 2015 D. Swarovski Distribution GmbH Swarovski® is a registered trademark of Swarovski AG.

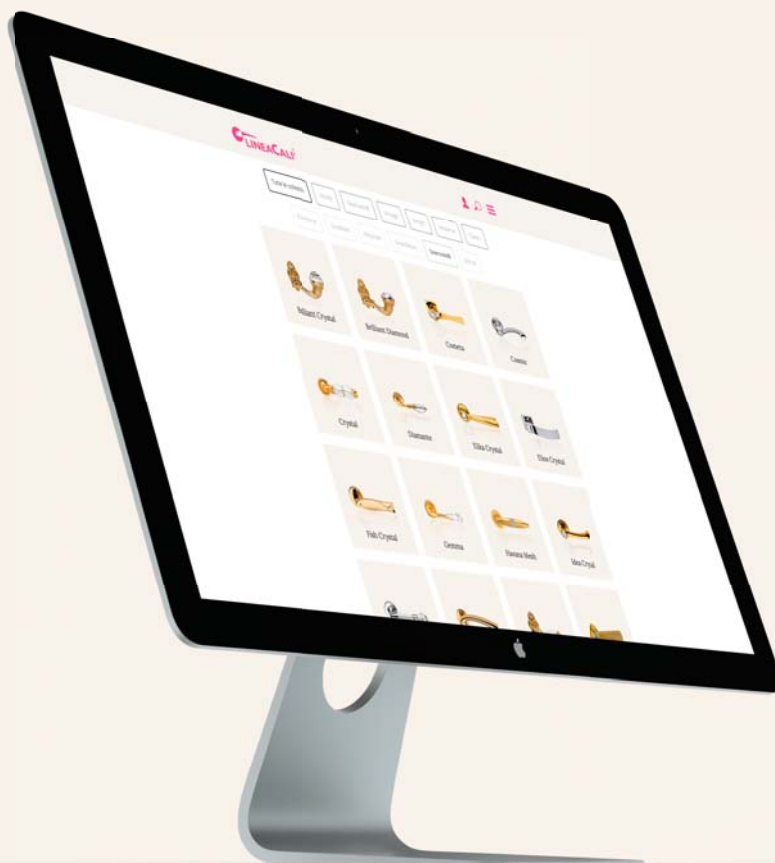

Giunto alla terza versione, il nuovo sito lineacali.it, con oltre 5.000 files a disposizione, si prefigge di diventare uno degli strumenti preferiti dagli architetti, design d'interni e privati.

Con un semplice click! potrete filtrare tutte le collezioni e trovare rapidamente la vostra maniglia preferita.

Ogni collezione è presentata in modo chiaro e completo: si parte con la foto pubblicitaria e il video di prodotto, per passare poi alle finiture, i modelli, l'approfondimento e il Media Center con le schede tecniche, i listini, le immagini, i disegni e i video.

Infine all'interno della sezione Download trovate tutte le pubblicazioni aziendali in formato PDF.

Che aspetti? Visita il sito lineacali.it e aggiungilo ai tuoi preferiti.

Now in its third version, the new lineacali.it website with over 5,000 files available, aims to become one of the favourite tools for architects, interior designers and home owners.

With a simple click! you can filter all the collections and quickly find your favourite handle.

Each collection is presented in a clear and complete way: starting with the advertising photo and product video, moving on to the finishes, models, an in-depth look and the Media Center with the technical sheets, prices lists, images, drawings and videos.

And in the Download section you will find all the company publications in PDF format.

What are you waiting for? Visit the lineacali.it site and add it to your favourites.

Per rimanere aggiornati sulle novità registratevi alla newsletter gratuita visitando il sito o fotografando con il vostro smartphone il QR Code riportato qui sotto.

To stay up-to-date on the latest news sign up for the free newsletter by visiting the website and taking a photo with your smartphone of the QR Code here below.



Newsletter italiana



English newsletter

I like it!

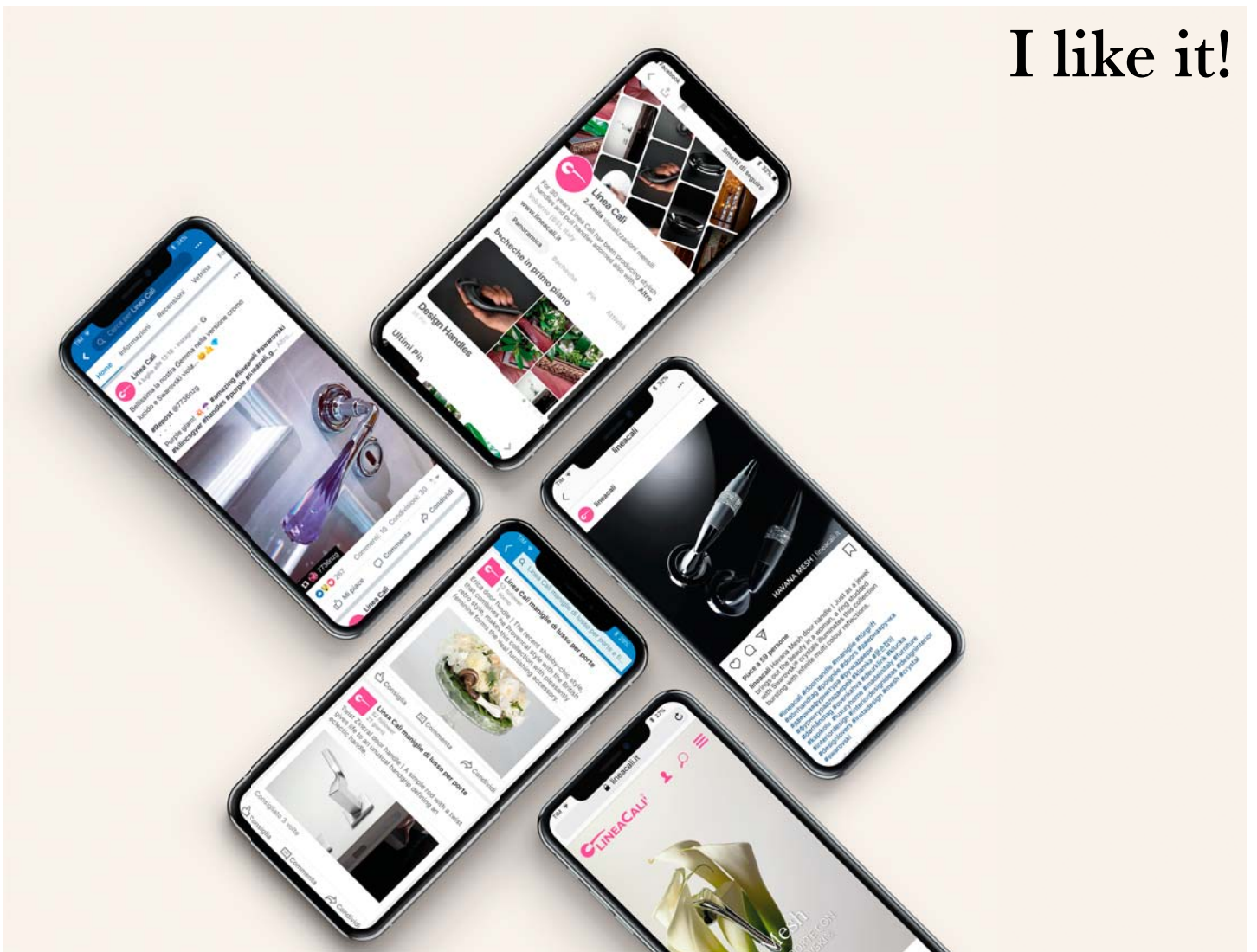

Linea Cali da alcuni anni gestisce numerosi social dove quotidianamente pubblica aggiornamenti sui prodotti, sull'azienda, sondaggi, e tutte le novità del momento.

Linea Cali has been managing a number of social media for a few years where it publishes daily updates on the products, the company, surveys and all the latest developments.

Diventare un follower Linea Cali è semplice: basta cercare "linea cali" all'interno del social preferito: Facebook, Instagram, Twitter, Pinterest, LinkedIn o Google+.

It's simple to become a Linea Cali follower: just search for "linea cali" in your favourite social network: Facebook, Instagram, Twitter, Pinterest, LinkedIn or Google+.



Facebook

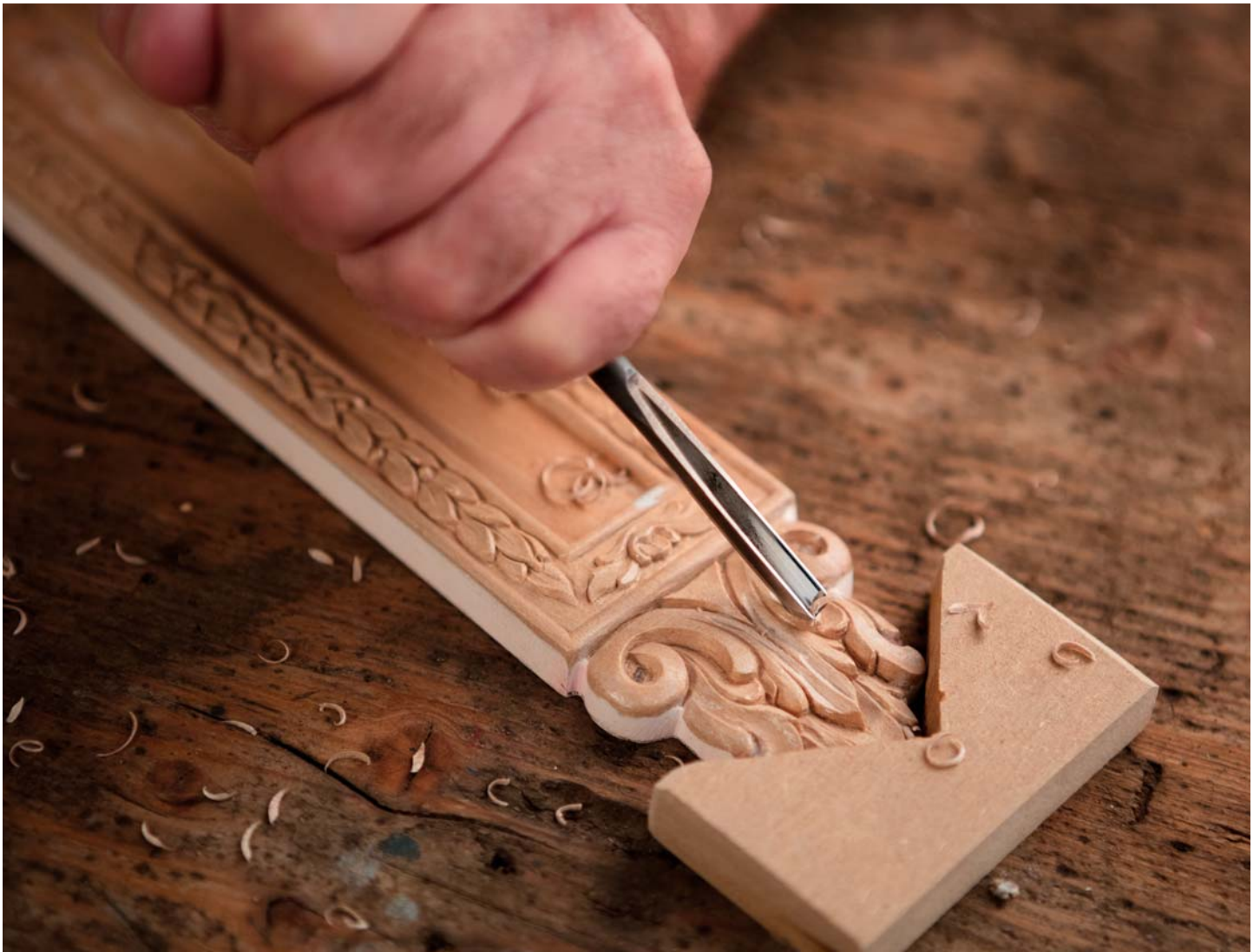

Linea Calì non produce delle semplici maniglie, ma oggetti unici e inimitabili.

A riprova dell'originalità di ogni prodotto e a tutela della Grande Creatività Italiana, le collezioni sono contrassegnate dal marchio Patented Design, un brevetto rilasciato dall'ente internazionale WIPO che promuove la protezione della proprietà intellettuale nel mondo.

Tutti i prodotti contrassegnati da questo marchio vi danno pertanto la garanzia di entrare in possesso di un oggetto unico nel suo genere e inimitabile.

Linea Calì does not produce simple handles, but unique and inimitable objects.

As proof of the originality of each product, the Linea Calì collections are marked Patented Design, a patent that is released by the international body WIPO that promotes the protection of intellectual property in the world.

All products bearing this mark therefore give you the guarantee of possessing a unique and inimitable object.



Perché le maniglie Linea Calì sono più belle delle altre?



5x

**Cromatura a spessore
Thick chrome plating**



**Tocco vellutato
Velvet finish**



**Anti impronta
Fingerprint resistance**



**Garanzia 10 anni
Ten year guarantee**

Il merito non è solo del design italiano, ma anche del particolare processo di finitura che fa la differenza: la cromatura a spessore.

Questo particolare trattamento fa sì che il cromo depositato sia fino a 5 volte superiore rispetto alle cromature standard, garantendo così una lucentezza senza pari a "prova di specchio", una sensazione particolarmente piacevole e vellutata al tocco, e un'elevatissima resistenza (le maniglie Linea Calì sono garantite 10 anni).

It's not just the Italian design but it's also the particular finishing process that makes the difference: the thick chrome plating.

The Linea Calì process of thick chrome plating involves the application of a layer that is 5 times greater than standard chroming. This guarantees an unparalleled brightness and a particularly pleasant and velvety sensation as well as high resistance (Linea Calì handles are covered by a 10 year guarantee).

SmartBlock



Senza il sistema di protezione da furti SmartBlock, è molto facile per i ladri entrare in casa. Prima con un trapano silenzioso praticano un foro nel serramento, poi inseriscono un ferro con una punta girevole, fanno leva sulla maniglia e aprono così la finestra con estrema facilità.

Without the SmartBlock system it is very easy for thieves to enter our homes. With a silenced drill they drill a hole in the window frame then they insert an iron rod with a rotating tip which they use to move the handle and open the window with extreme ease.

Con questo metodo in soli 20 secondi un ladro riesce a entrare in casa.

It is estimated that with this method a criminal gains access to a household in just 20 seconds.



Installando le maniglie SmartBlock, grazie al particolare sistema che blocca la rotazione della maniglia, il ladro non riesce a introdursi in casa, evitando così spiacevoli sorprese.

With SmartBlock the thief is unable to open the window because the rotation of the handle is prevented by the security system and so the inhabitants of the house can live serenely and peacefully.



Sempre in funzione, 24h/24h
Always in operation, 24-7-365



Sicuro anche per i bambini
Also safe for children



Totalmente invisibile
Totally invisible



Oltre 80 modelli e 15 finiture
Over 80 models and 15 finishes



Facile da installare
Easy to install



Installabile su tutti gli infissi
Can be installed on all types of window

Qualità italiana al 100%



Linea Cali è orgogliosa di garantire la produzione italiana di tutti i prodotti nel rispetto delle più recenti normative Europee in tema di qualità delle materie prime utilizzate, caratteristiche tecniche e resistenza dei trattamenti protettivi delle superfici.

A riprova di ciò ogni articolo che supera con esito positivo i numerosi test di laboratorio, viene "firmato" con il marchio Linea Cali che ne attesta l'autenticità, garantendo così al cliente l'acquisto di una maniglia di alta qualità interamente prodotta in Italia.

Linea Cali garantisce 10 anni i prodotti con finiture cromo lucido o cromo satinato e 20 anni se trattati con il procedimento Zirconium protection (PVD), adatto dove è richiesta una resistenza particolare a causa di difficili situazioni climatiche come salsedine, alta umidità o situazioni di impiego usuranti.

Linea Cali is proud to guarantee that all its products are manufactured in Italy in compliance with the most recent European standards on the quality of the raw materials used, the technical characteristics and the resistance of the surface protective treatments.

As proof of this, each article that successfully passes the numerous laboratory tests is "signed" with the Linea Cali mark that certifies its authenticity, demonstrating that the client has purchased a high quality handle that is produced entirely in Italy.

Linea Cali products with a polished or satin chrome finish are covered by a 10 year guarantee and if they are treated with Zirconium protection (PVD) they are covered by a 20 year guarantee. This treatment is suitable where high resistance is required due to tough climatic conditions such as high humidity and sea salt or situations of strenuous use.

Rosette e bocchette autobloccanti per mercati scandinavi



Linea Cali, sempre attenta alle esigenze del mercato, ha brevettato delle innovative rosette e bocchette coprivite per porte con serrature di standard scandinavo Assa e Boda.

Queste particolari rosette incorporano un sistema antirotazionale costituito da particolari lamelle, che si adattano e aderiscono all'interno del foro praticato nella porta (da $\varnothing 38$ a $\varnothing 42$ mm) e impediscono la rotazione garantendo così un montaggio a regola d'arte, anche e soprattutto nei casi di utilizzo di rosette quadrate.

Linea Cali, always attentive to market requirements, has patented innovative roses and keyholes with screw covers with Assa and Boda Scandinavia standard locks.

These particular roses incorporate an anti-rotation system made up of special strips that fit and adhere to the inside of the hole made in the door (from $\varnothing 38$ to $\varnothing 42$ mm) and prevent rotation, thus ensuring a perfect installation, especially when square roses are used.

Sistema montaggio ultra rapido Click-clack



L'innovativo sistema di montaggio ultrarapido click-clack, grazie a un particolare sistema di fissaggio, permette a chiunque di montare in pochi istanti una maniglia senza la necessità di utensili o viti.

The click-clack innovative ultra-rapid mounting system, thanks to a particular fixing system allows anyone in just a few minutes to mount a handle without the use of tools or screws.



Riduzione dei costi

Riducendo le dimensioni degli imballi i costi di stoccaggio e di trasporto diminuiscono sensibilmente.

Reduction in costs

By reducing the packaging dimensions, storage and transport costs are significantly reduced.



Riduzione dei danni

Grazie all'assenza iniziale delle maniglie, l'eventualità di danneggiare le porte durante il trasporto o in cantiere si riduce ai minimi termini.

Reduction in damages

Thanks to the initial absence of handles, the chances of damaging the doors during transport and on site are reduced to a minimum.



Riduzione dei tempi di evasione degli ordini

Potendo creare una scorta a magazzino personalizzabile all'istante, il tempo di evasione degli ordini si riduce sensibilmente.

Reduction in order processing times

By enabling the creation of a customizable stock in the warehouse, order processing times are significantly reduced.



Maggiore trasportabilità

La movimentazione delle porte è più facile e lo spazio occupato si riduce sensibilmente consentendo di guadagnare spazio per ulteriori ordini.

Better handling

Handling of doors is easier and the space occupied is greatly reduced thus increasing the space for other orders.

contemporary handles

COLLEZIONE / COLLECTIONS	COD.	PAG.
Ala	1385	26
Aqua	1440	28
Brera	-	30
Duna	1410	32
Elios	1341	34
Elle	1050	36
Elle Pelle	-	40
Era	1600	42
Fish	692	46
Ibis	691	48
Jet	1425	50
Kendo	1516	52
Komfort	1455	54
Nau	1548	56
Open	1105	58
Point	1595	62
Prisma	1280	64
Riflesso	1360	66
Rombo	1420	68
Sintesi	1300	70
Sintesi Wengé	1304	72
Slim	1110	74
Slim Pelle	-	76
Spirit	1450	78
Thais	1155	80
Wind	1655	82
Zen	1156	84
Zen Fusion	1585	86
Zen Wengé	1158	88

contemporaneo

Ala

La mano scivola sul dorso della maniglia come il vento sulle ali di un aeroplano, ma il design consapevole dona una presa estremamente solida, confortevole e sicura.

Your hand glides over the handle like the wind on the wings of an airplane, but the conscious design results in an extremely solid, comfortable and secure grip.

made in Italy | patented design





Cromo lucido
polished chrome
CR



Cromo satinato
satin chrome
CS



Ottone lucido verniciato
polished brass
OL



Nero opaco
matt black
VE



1385 RB 019

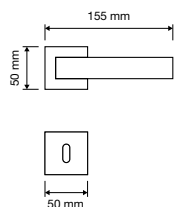

1385 RB 024

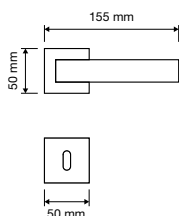

1385 PL

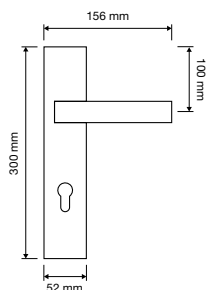

1385 SK

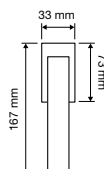

Aqua

I motivi che la risacca del mare disegna sulla battigia caratterizzano l'inusuale forma di questa collezione dal design particolarmente moderno ed evocativo.

The patterns that the surf of the sea draw on the shoreline characterize the unusual form of this collection with a particularly modern and evocative design.

made in Italy | patented design





bronzo opaco
matt bronze
BM



cromo lucido
polished chrome
CR



cromo satinato
satin chrome
CS



oro zecchino
gold plated
OZ



1440 RB 019

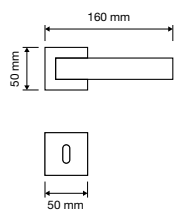

1440 RB 024 <>

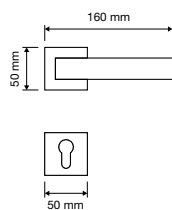

1440 PL

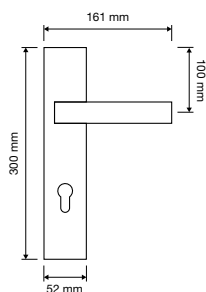

1440 SK 🔒

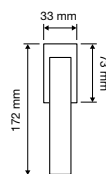

Brera

Ispirata alle più grandi opere di Mondrian, Kandinsky e Pollock, la collezione Brera eleva la forma, le linee e i colori grazie al concetto di astrazione, dichiarando la propria "fisicità" solo in alcune sue caratteristiche.

Inspired by the greatest works of Mondrian, Kandinsky and Pollock, the Brera collection elevates form, lines and colours thanks to the concept of abstraction, declaring its "physical" nature in just a few of its characteristics.

made in Italy





Cromo lucido
 polished chrome
 CR



Cromo satinato
 satin chrome
 CS



Oro zecchino
 gold plated
 OZ

fantasie / fantasy



1171



1172



1173



1175



1178



1181

modelli / models



1173 RB 019

1173 RB 024

1173 PL

1173 SK

1173 PI

1173 PT

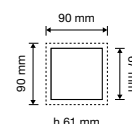
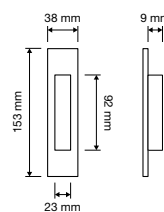
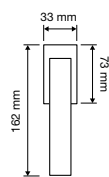
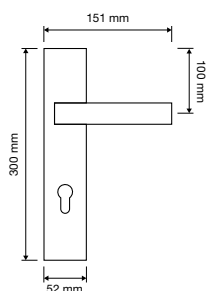
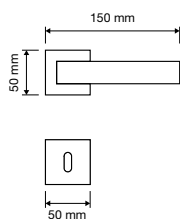
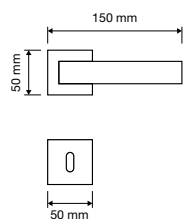

Duna

Plasmata dalla forza del vento, esprime la sensazione di mistero e maestosità del deserto.

Shaped by the force of the wind, it conveys the sensation of mystery and majesty of the desert.

made in Italy | patented design





bronz
opaco
matt bronze
BM



cromo lucido
polished chrome
CR



cromo satinato
satin chrome
CS



oro zecchino
gold plated
OZ

modelli / models

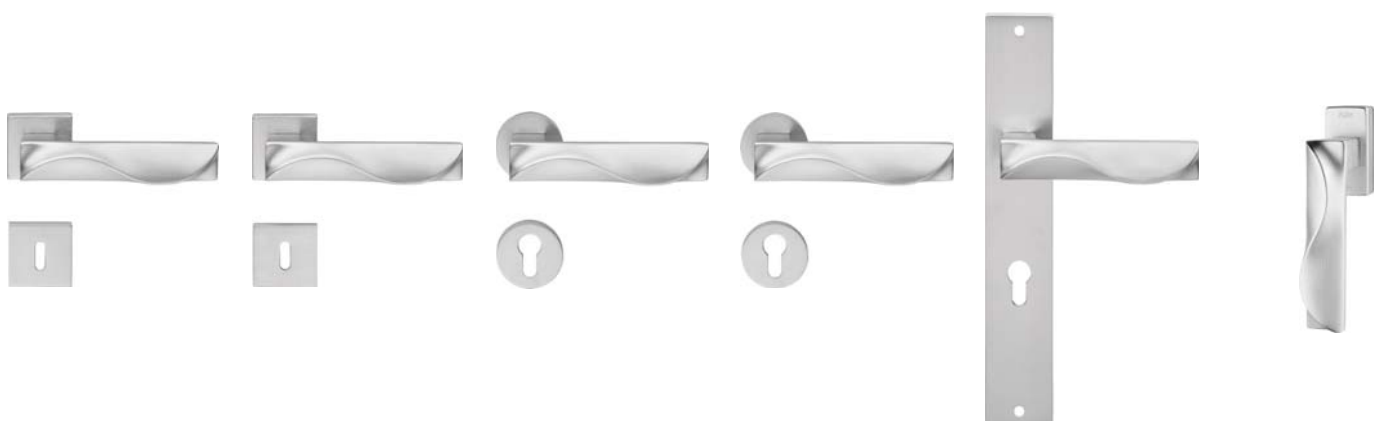

1410 RB 019

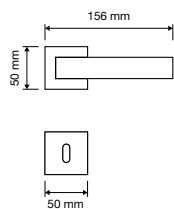

1410 RB 024

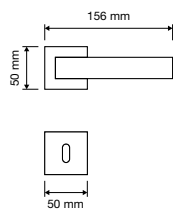

1410 RB 023

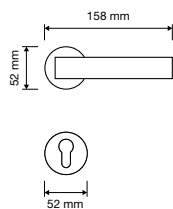

1410 RB 025

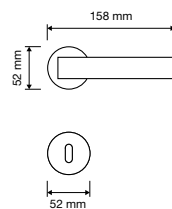

1410 PL

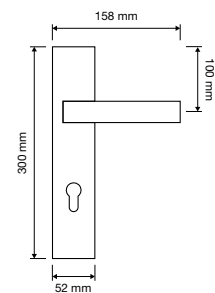

1410 SK

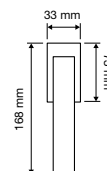

Dynamic

Un pattern a onde tridimensionale definisce l'impugnatura della maniglia dialogando con i volumi squadrate che lo contengono.

A three-dimensional pattern defines the handgrip of this handle communicating with the squared volumes that contain it

made in Italy | patented design

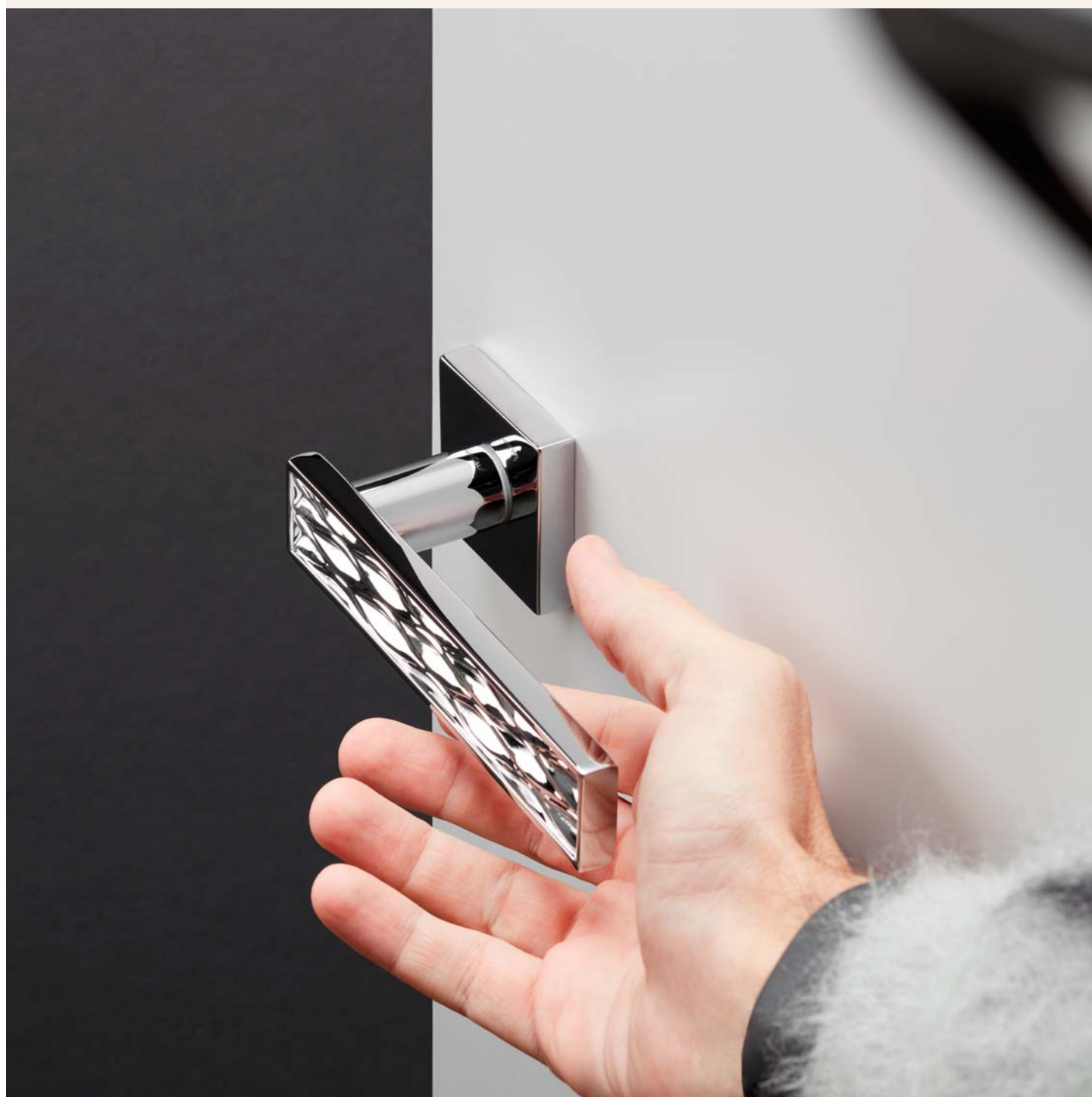



bronzo opaco
matt bronze
BM



cromo lucido
polished chrome
CR



cromo satinato
satin chrome
CS



oro zecchino
gold plated
OZ



patiné
patiné matt
PM

modelli / models



1645 RB 019

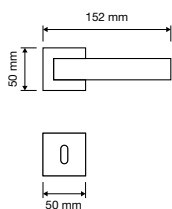

1645 RB 024

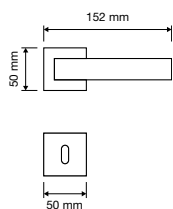

1645 RB 023

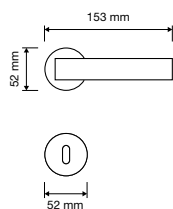

1645 RB 025

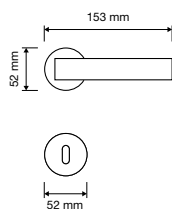

1645 PL

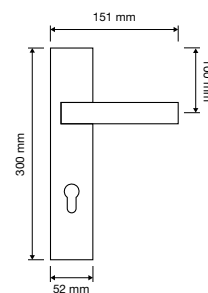

1645 SK

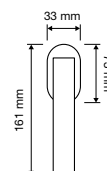

Elios

Una collezione sofisticata contraddistinta da una "doppia personalità" che cambia in funzione del punto di vista; moderna ma classica, importante ma sottile e raffinata.

A sophisticated collection characterized by a "dual personality" that changes according to the point of view; modern but classic, important but slender and refined.

made in Italy | patented design





Cromo lucido
polished chrome
CR



Cromo satinato
satin chrome
CS



Cromo + cromo sabbato
chrome + matt chrome mix
CM



Oro + oro sabbato
polished gold + matt gold mix
MO



Oro zecchino
gold plated
OZ



1341 RB 019

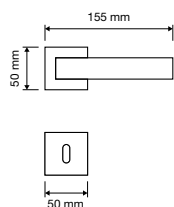

1341 RB 024 <>

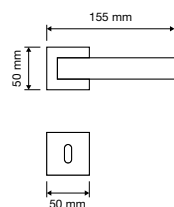

1341 PL

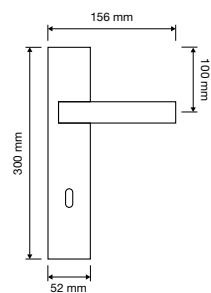

1341 SK

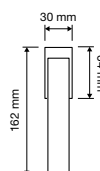

Elle

L'unione di più elementi differenti fra loro, tondi e quadri, dà vita a una collezione sofisticata e semplice al tempo stesso.

The combination of several different elements, round and square, gives life to a sophisticated but at the same time simple collection.

made in Italy





cromo satinato + cromo satin chrome + polished chrome mix CC



cromo lucido polished chrome CR



cromo satinato satin chrome CS



ottone lucido verniciato polished brass OL



ottone satinato + ottone lucido satin brass + polished brass mix OT



oro zecchino gold plated OZ



1050 RB 019

1050 RB 024

1050 RB 102



1050 SK



1050 CH

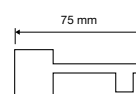
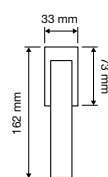
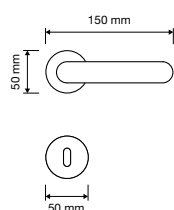
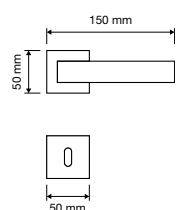
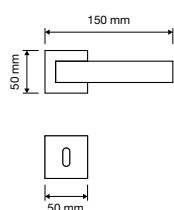



1050 MN 240

interassi disponibili / available distances
240 - 320 - 440 - 500 - 800

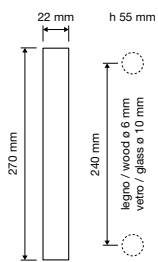

1050 MZ 240

interassi disponibili / available distances
240 - 320 - 440 - 500 - 800

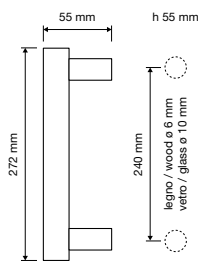

Elle Pelle

L'unione di più elementi differenti fra loro, tondi e quadri, dà vita a una collezione sofisticata e semplice al tempo stesso.

The combination of several different elements, round and square, gives life to a sophisticated but at the same time simple collection.

made in Italy





Cromo lucido
polished chrome
CR



Cromo satinato
satin chrome
CS



Oro zecchino
gold plated
OZ

fantasie / fantasy



pelle nera
black leather
1052



pelle marrone
brown leather
1051

modelli / models



1052 RB 019

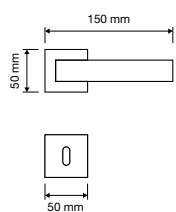

1052 RB 102

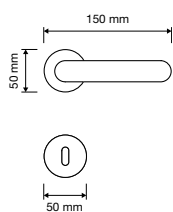

1052 PL

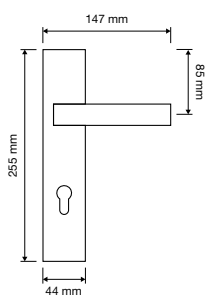

1052 SK

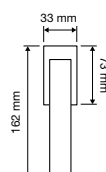

1052 MN 240

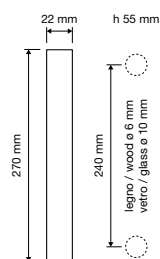

1052 MZ 240

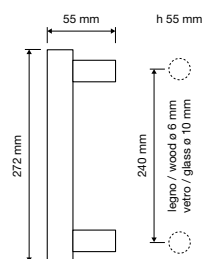

Era

Il design moderno si combina con quello antico, in un design particolarissimo e unico che collega l'arte di un tempo alla funzionalità odierna con maestria ed eleganza.

Modern and antique come together in a very special and unique design that skilfully and elegantly unites the art of yesterday with the functionality of today.

made in Italy | patented design





antracite satinato + cromo lucido
anthracite satin + polished chrome
AC



antracite satinato + oro zecchino
anthracite satin + gold plated
AG



antracite satinato + patiné
anthracite satin + patiné mat
AM



cromo satinato + cromo lucido
satin chrome + polished chrome
CC



nero opaco + cromo lucido
matt black + polished chrome
CE



bronzo opaco + patiné
matt bronze + patiné mat
NP



nero opaco + nero francese
matt black + french black
VN



oro zecchino + cromo lucido
gold plated + polished chrome
ZC



nero opaco + oro zecchino
matt black + gold plated
ZO



1600 RB 019

1600 RB 024 

1600 PL

1600 SK 

1600 MN 400

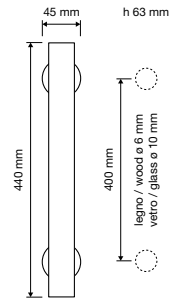
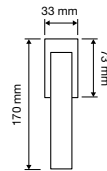
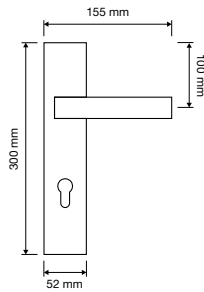
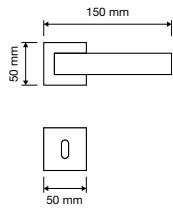
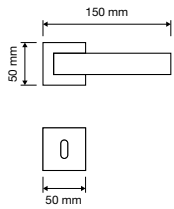

interassi disponibili /
available distances
300 - 400

Fish

Morbidezza e fluidità in una linea affusolata, con un richiamo esplicito all'ambiente marino.

Softness and fluidity in a streamlined design with an explicit reference to marine environments.

made in Italy | patented design





bronzo opaco
matt bronze
BM



cromo lucido
polished chrome
CR



cromo satinato
satin chrome
CS



cromo + cromo sabbato
chrome + matt chrome mix
MC



oro + oro sabbato
polished gold + matt gold mix
OM



oro zecchino
gold plated
OZ



692 RB 023

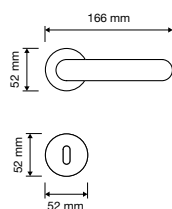

692 RB 025 

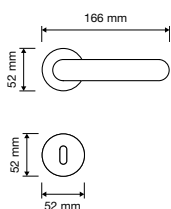

692 PL

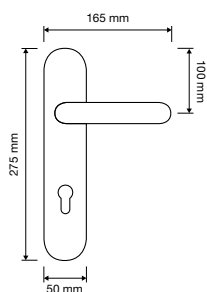

692 SK 

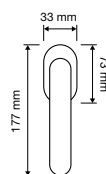

Ibis

Linee sinuose si rincorrono dando vita a una forma naturale che, idealmente, ricorda un ramo sulla quale si è appoggiato l'Ibis, uccello americano dal piumaggio rosso come il tramonto.

Sinuous lines follow each other giving life to a natural form that ideally resembles a branch on which an ibis is perched, an American bird with scarlet feathers like a sunset.

made in Italy | patented design





Cromo lucido
polished chrome
CR



Cromo satinato
satin chrome
CS



Ottone lucido verniciato
polished brass
OL



Oro zecchino
gold plated
OZ



Patiné
patiné mat
PM



Nero opaco
matt black
VE



691 RB 023

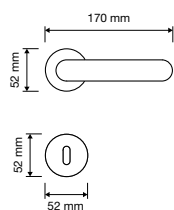

691 RB 025

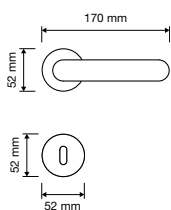

719 PL

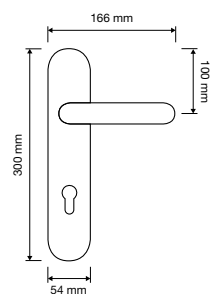

691 SK

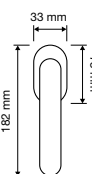

691 MN 300

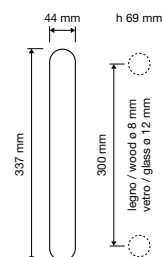

Jet

Linee taglienti, sapientemente smussate e perciò morbide e piacevoli al tatto, talmente perfette e armoniche da non dover aggiungere altro.

Sharp, cleverly contoured lines and hence soft and pleasant to the touch, so perfect and harmonious that there's no need to add anything else.

made in Italy | patented design

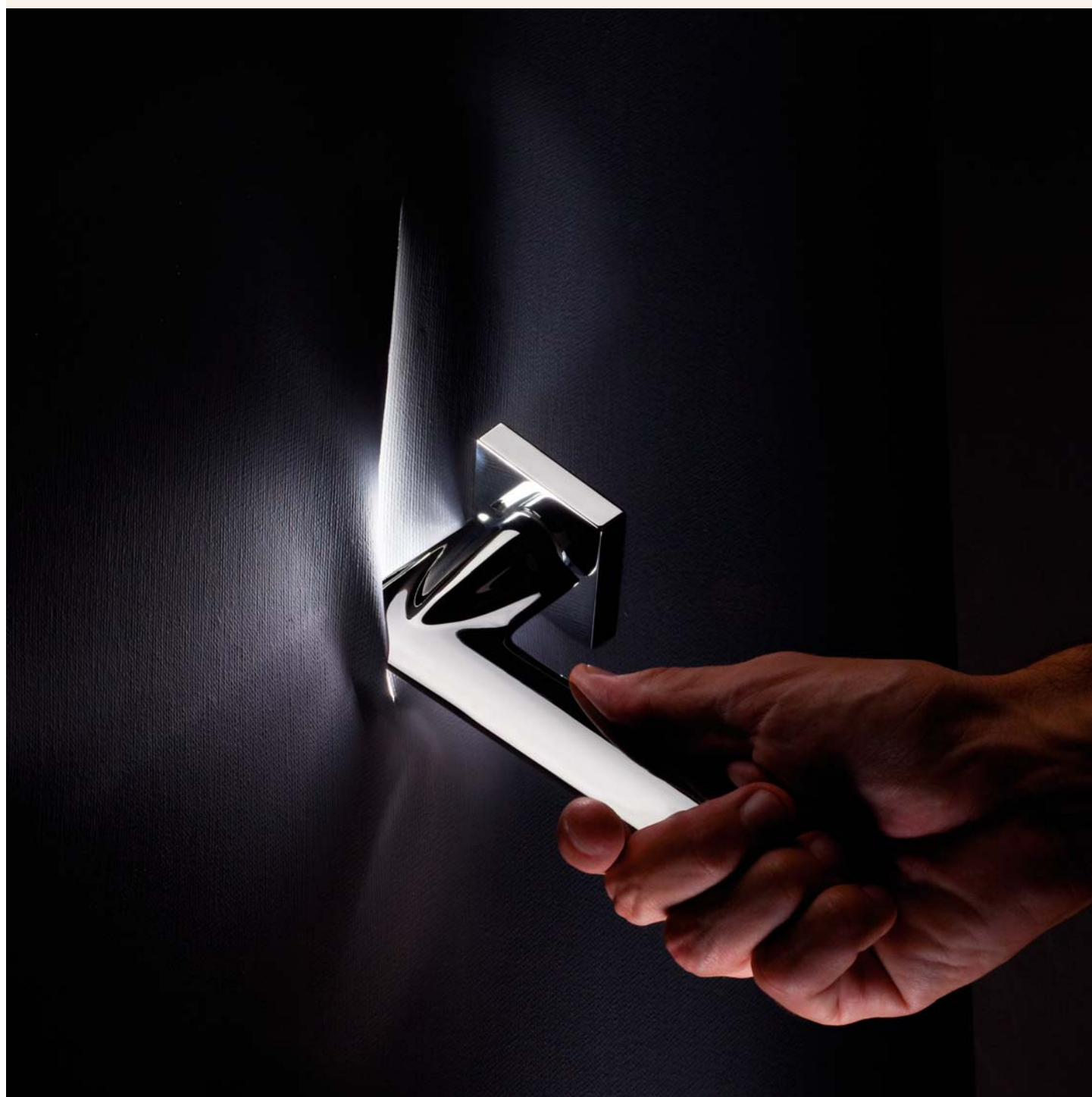



cromo lucido
polished chrome
CR



cromo satinato
satin chrome
CS



oro zecchino
gold plated
OZ



nero opaco
matt black
VE

modelli / models

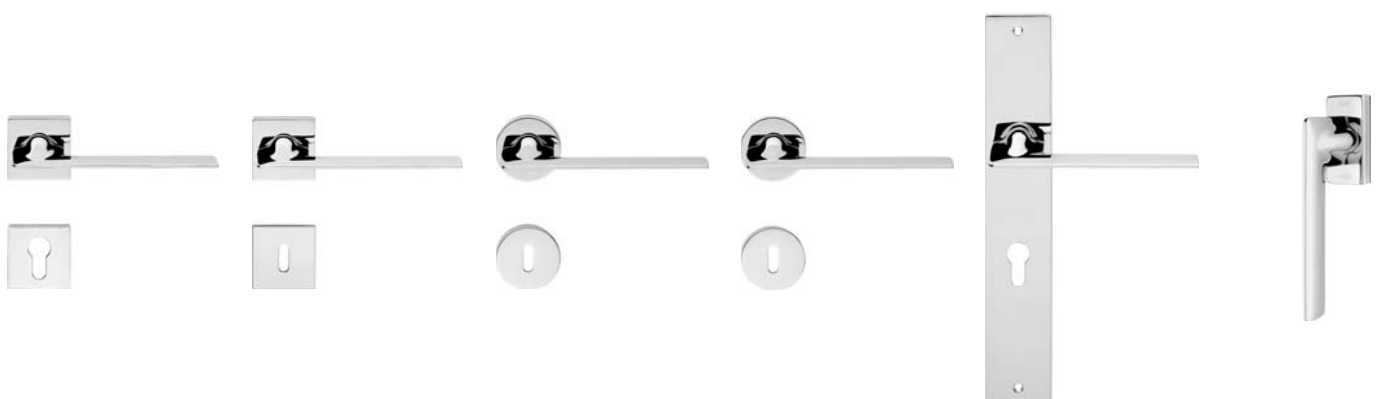

1425 RB 019

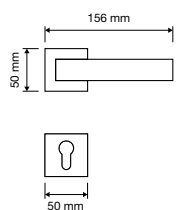

1425 RB 024

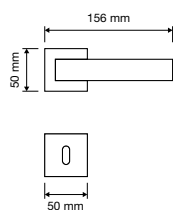

1425 RB 023

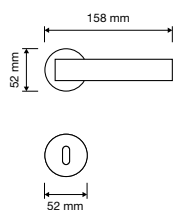

1425 RB 025

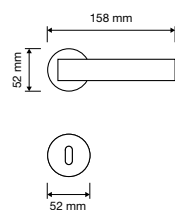

1425 PL

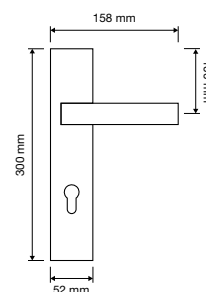

1425 SK

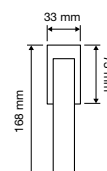

Kendo

Ispirata allo Shinai, la spada utilizzata dai Samurai, questa collezione definisce una nuova via del design contemporaneo.

Inspired by Shinai, the sword used by the Samurai, this collection defines a new way of contemporary design.

made in Italy | patented design





bronzopaco
matt bronze
BM



chromo lucido
polished chrome
CR



chromo satinato
satin chrome
CS



oro zecchino
gold plated
OZ

modelli / models



1516 RB 023

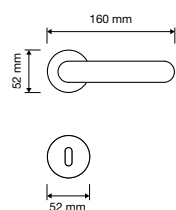

1516 RB 025

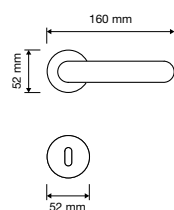

1518 PL

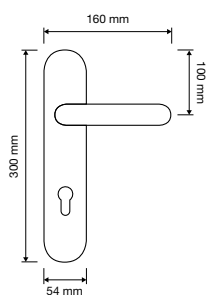

1516 SK

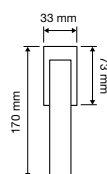

1516 MN 390

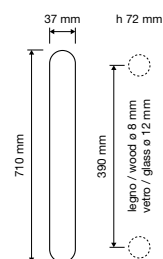

1516 MZ 300

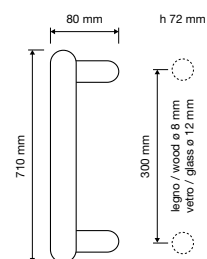

Komfort

Una maniglia dalle molteplici personalità, ironica e giocosa, pragmatica e complessa, dove le linee si rincorrono dando vita a una forma indefinibile ma "concreta".

A handle with multiple personalities, ironic and playful, pragmatic and complex, where the lines follow one another giving life to an undefinable but "concrete" form.

made in Italy | patented design

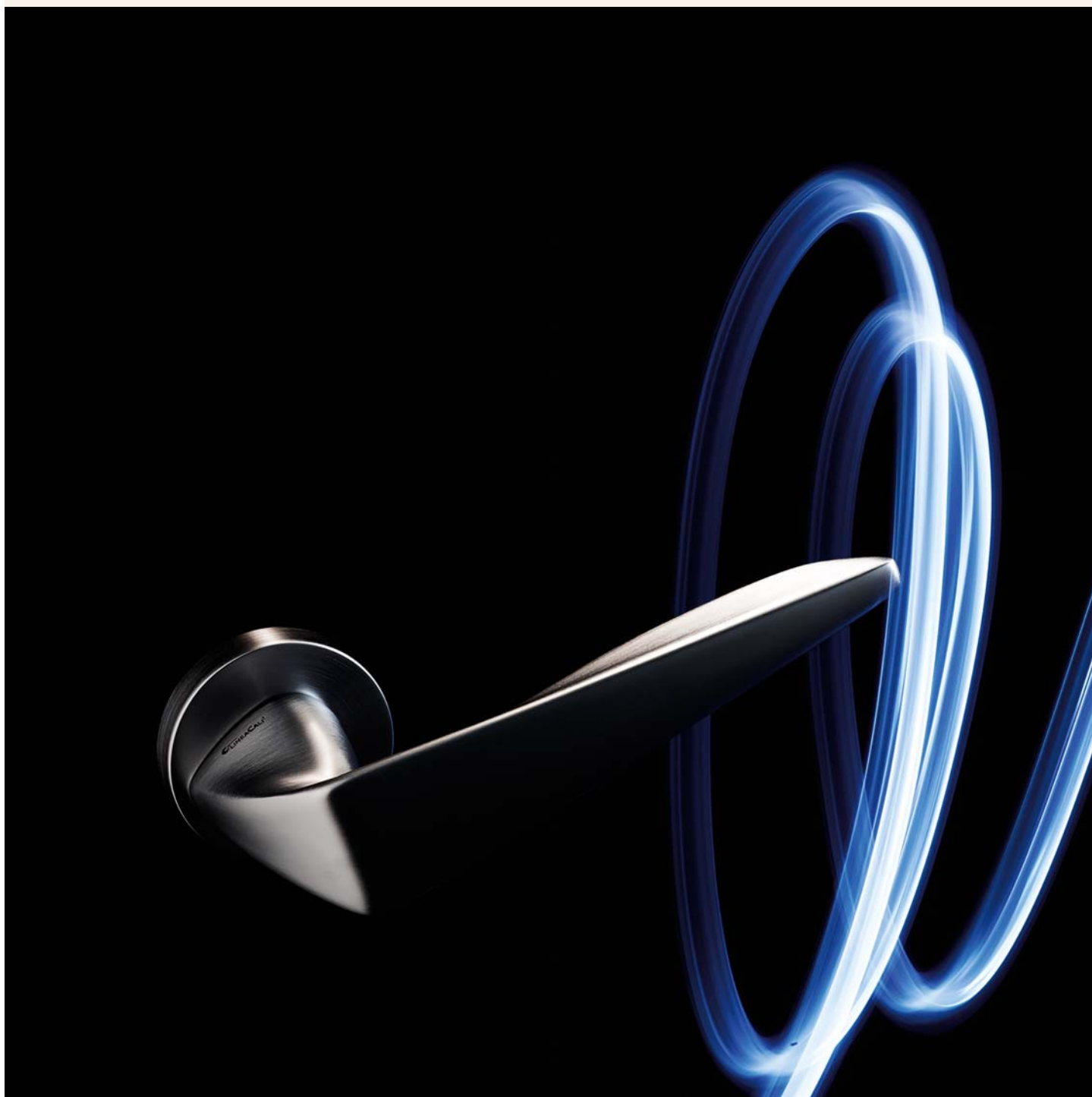



cromo lucido
polished chrome
CR



cromo satinato
satin chrome
CS



oro zecchino
gold plated
OZ



patiné
patiné mat
PM



1455 RB 023

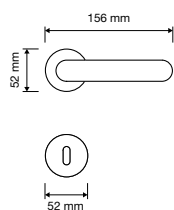

1455 RB 025

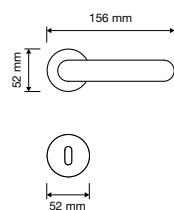

1457 PL

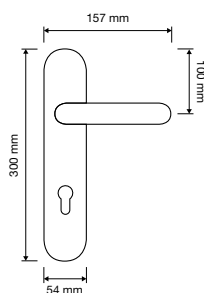

1455 SK

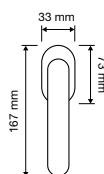

Nau

Una spirale di design che, grazie all'insolita silhouette, funge da elemento di stacco e congiunzione con lo spazio circostante

A spiral design which, thanks to the unusual silhouette, acts as an element of separation and conjunction with the surrounding space.

made in Italy | patented design

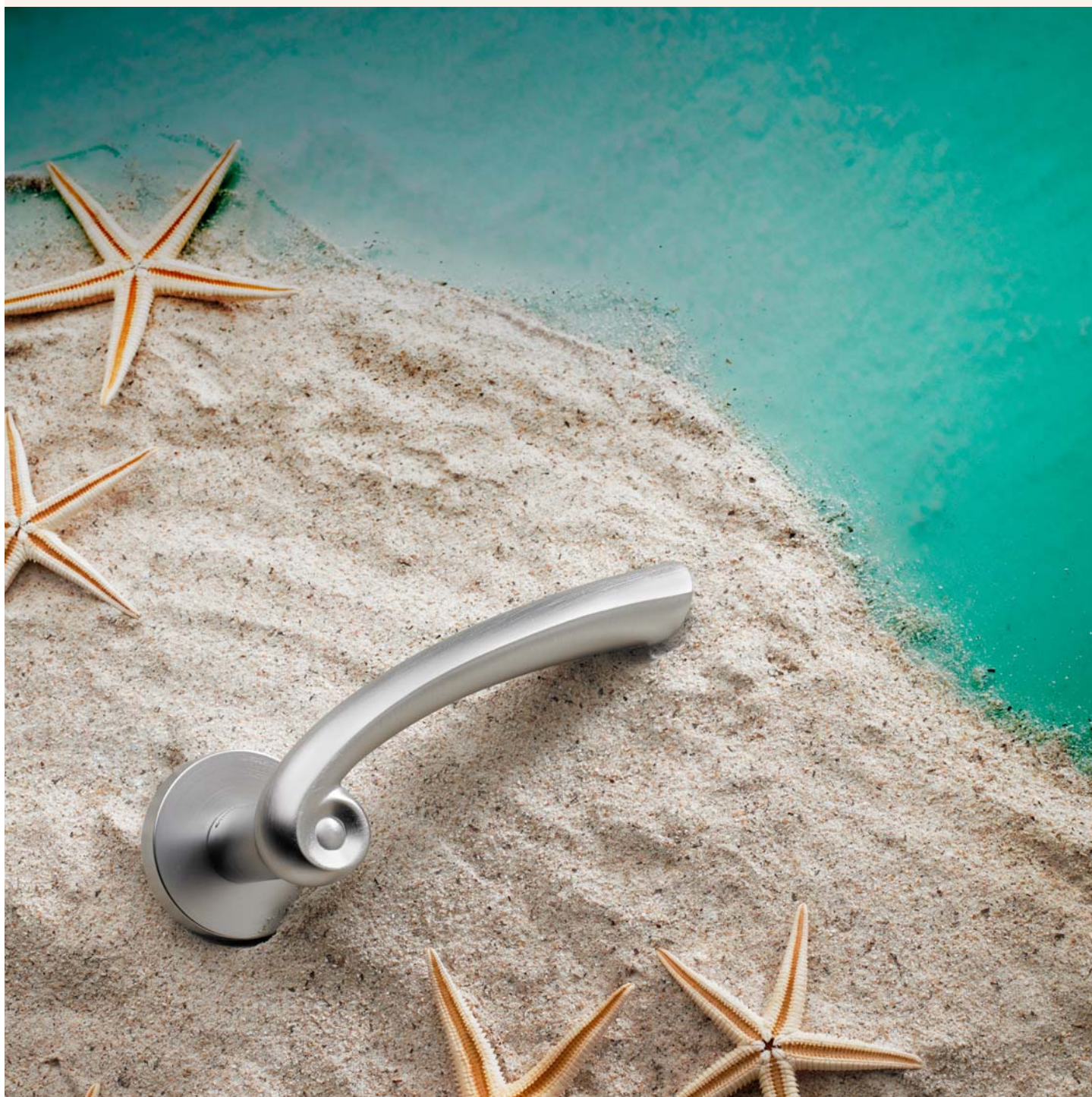



bronzo opaco
matt bronze
BM



cromo lucido
polished chrome
CR



cromo satinato
satin chrome
CS



oro zecchino
gold plated
OZ



1548 RB 023

1548 RB 025 

1552 PL

1548 SK 

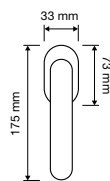
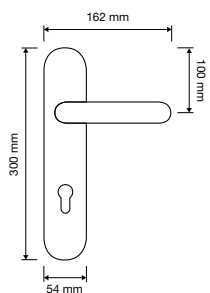
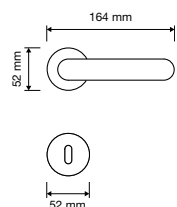
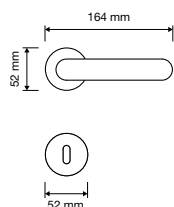

Open

Un'interessante parentesi [quadra] di stile in grado di valorizzare ogni porta con un tocco di originalità.

An interesting digression of style [square bracket] capable of adding value to all doors with a touch of originality.

made in Italy

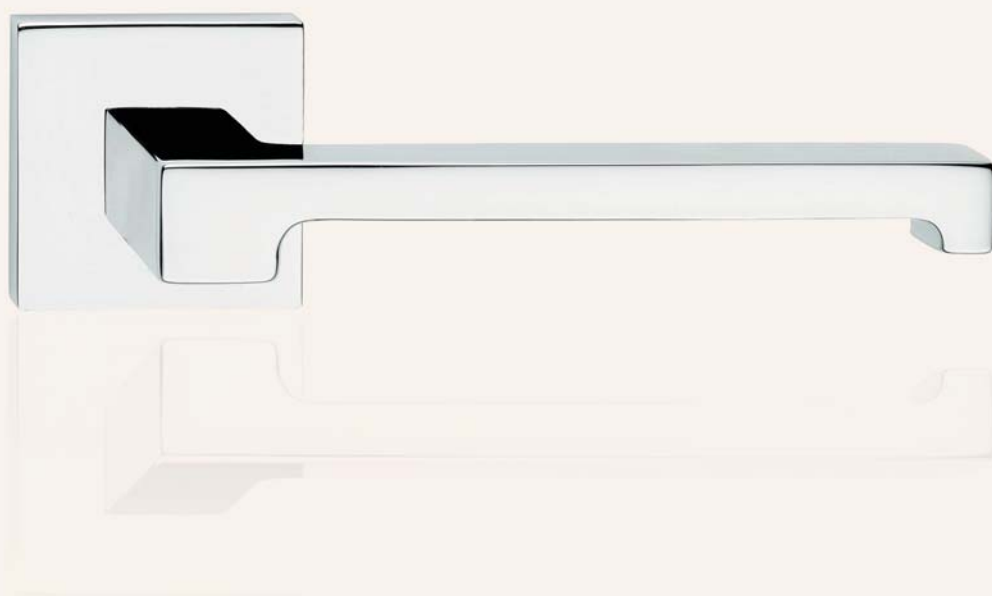



Cromo lucido
polished chrome
CR



Cromo satinato
satin chrome
CS

modelli / models



1105 RB 019

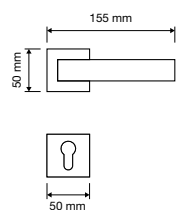

1105 RB 024

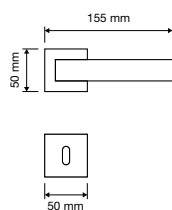

1105 RB 090

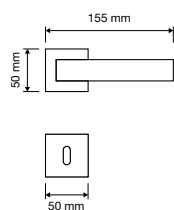

1104 PL

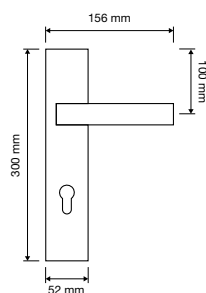

1105 SK

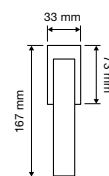



1105 PT

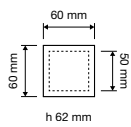

1105 PG

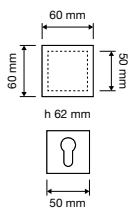

1105 MN 207

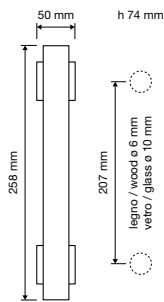

1104 SL

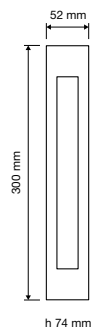

1104 ED/ES

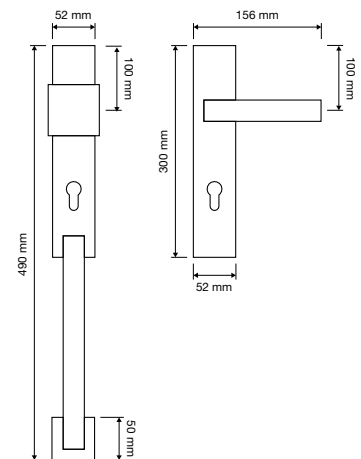

Point

Una collezione di maniglie priva di ogni orpello e per questo estremamente sofisticata e unica nel suo genere.

A collection of handles without any frills and for this reason extremely sophisticated and unique.

made in Italy | patented design





antracite satinato
satin anthracite
AS



cromo lucido
polished chrome
CR



cromo satinato
satin chrome
CS



oro zecchino
gold plated
OZ

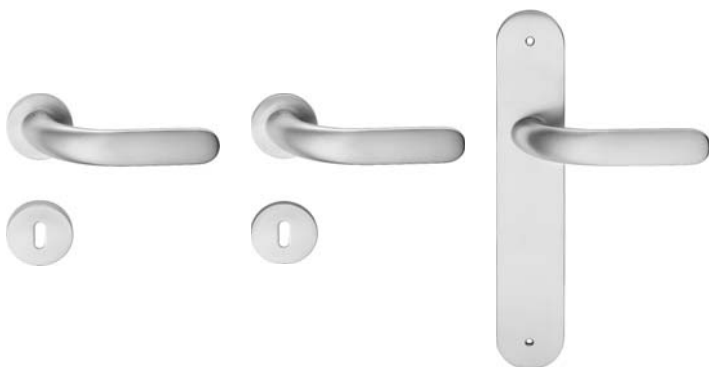

1595 RB 023

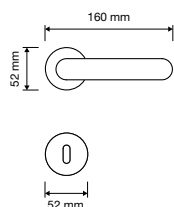

1595 RB 025

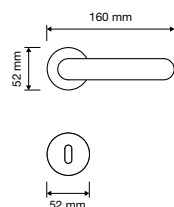

1595 PL

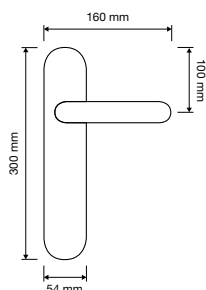

1595 SK

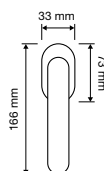

Prisma

Il design particolarmente eclettico e inconsueto, caratterizzato da un'impugnatura di forma romboidale, ne fa il complemento d'arredo ideale per gli ambienti più moderni.

The particularly eclectic and unusual design, characterized by the rhomboid shaped handgrip, make it the ideal furnishing accessory for the most modern environments.

made in Italy | patented design





cromo lucido
polished chrome
CR



cromo satinato
satin chrome
CS



cromo + cromo sabbato
chrome + matt chrome mix
MC



ottone lucido verniciato
polished brass
OL



oro + oro sabbato
polished gold + matt gold mix
OM



1280 RB 019

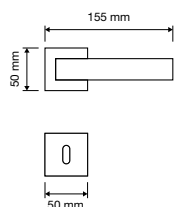

1280 RB 024 ><

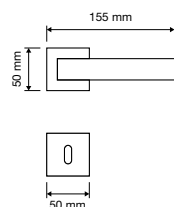

1281 PL

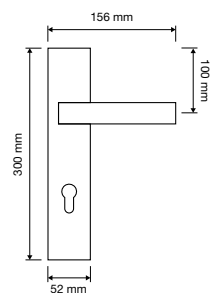

1280 SK 🔒

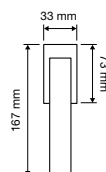

Riflesso

Una collezione che vuole essere protagonista, caratterizzata da un'impugnatura importante capace di riflettere l'ambiente circostante.

A collection that aims for the leading role, characterised by an imposing handgrip that is capable of reflecting its surroundings.

made in Italy | patented design





Cromo lucido
polished chrome
CR



Cromo satinato
satin chrome
CS



Nero opaco
matt black
VE

modelli / models



1360 RB 019

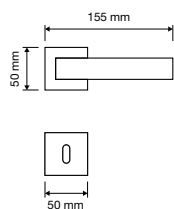

1360 RB 024

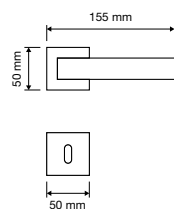

1360 PL

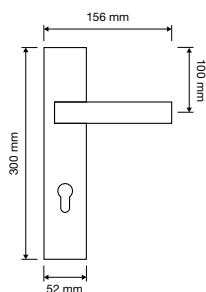

1360 SK

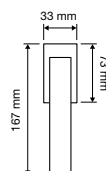

Rombo

Un design eclettico che non scende a compromessi dedicato a chi è coraggioso e determinato nello stile.

An eclectic design without compromise dedicated to those looking for a daring and determined style.

made in Italy | patented design

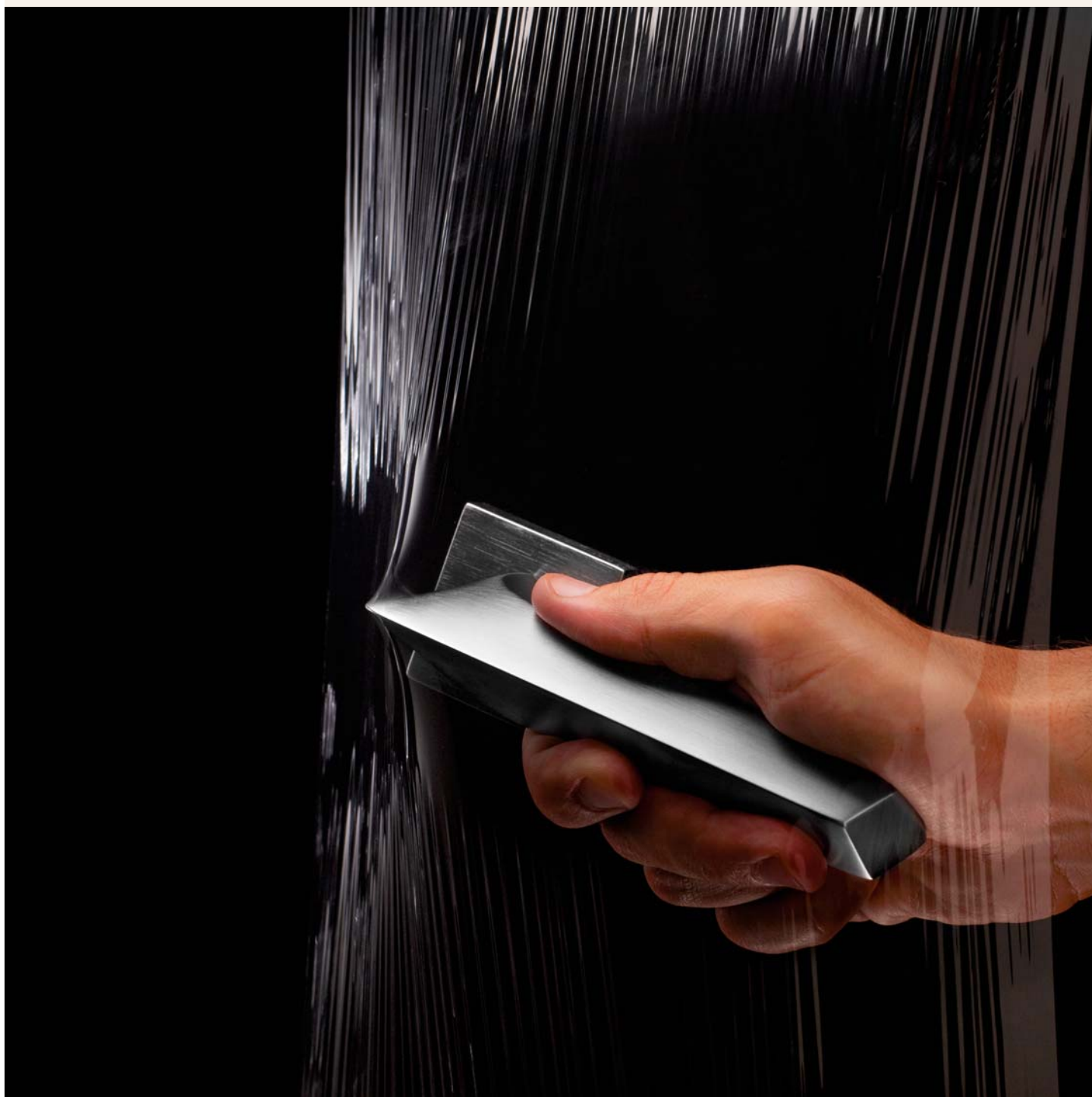



cromo lucido
polished chrome
CR



cromo satinato
satin chrome
CS



oro zecchino
gold plated
OZ

modelli / models



1420 RB 019

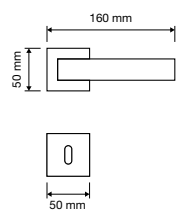

1420 RB 024

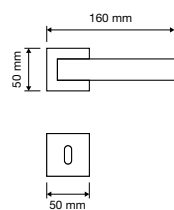

1420 PL

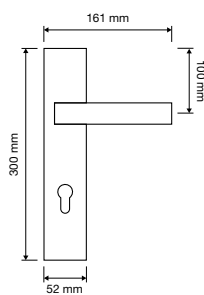

1421 PL

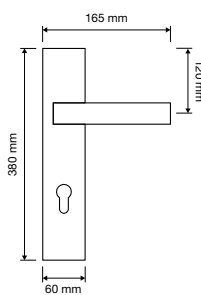

1420 SK

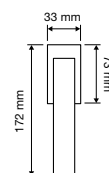

Sintesi

Linee decise, lineari ed estremamente rigorose, ne fanno un complemento d'arredo perfetto per tutti quegli ambienti dove il design regna sovrano.

Decisive, linear and extremely meticulous lines, make it the perfect furnishing accessory for all surroundings where design reigns supreme.

made in Italy





Cromo lucido
polished chrome
CR



Cromo satinato
satin chrome
CS



Ottone lucido verniciato
polished brass
OL

modelli / models



1300 RB 019

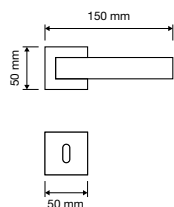

1300 RB 024

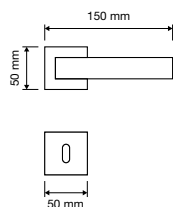

1300 PL

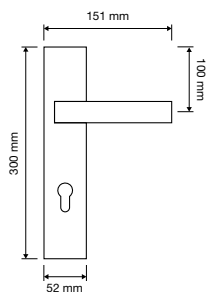

1300 SK

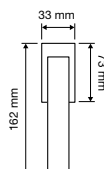

Sintesi Wengé

Il fascino del legno pregiato proveniente dalle foreste tropicali dona un tocco quasi esotico a questa collezione, caratterizzata da linee estremamente semplici e pulite.

The fascination of precious wood from tropical forests gives this collection an almost exotic taste, characterised by extremely simple and clean lines.

made in Italy





Cromo lucido
polished chrome
CR



Cromo satinato
satin chrome
CS



Oro zecchino
gold plated
OZ

modelli / models



1304 RB 019

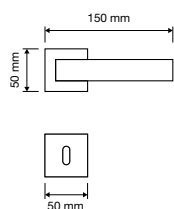

1304 RB 024

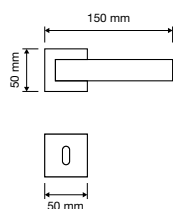

1304 PL

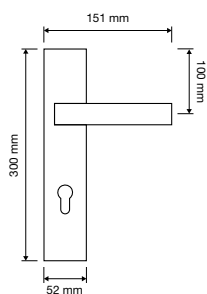

1304 SK

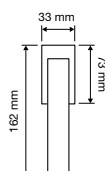

Slim

Un gioco di forme e volumi differenti contraddistingue il design di questa collezione che gioca con le differenti proporzioni di ogni sua componente.

A combination of different forms and volumes characterises the design of this collection that plays with the different proportions of each component.

made in Italy



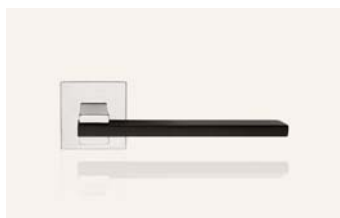

nero paco + cromo lucido
matt black + polished chrome
CE



cromo lucido
polished chrome
CR



cromo satinato
satin chrome
CS



ottone stainato
satin brass
OS

modelli / models

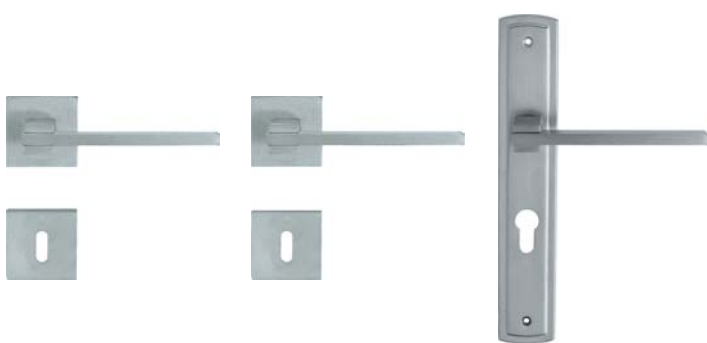

1110 RB 019

1110 RB 024 ><

1110 PL



1110 SK 🔒



1110 MN 240



1110 MZ 240

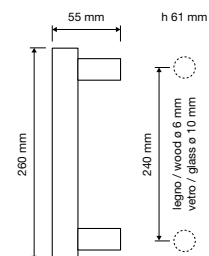
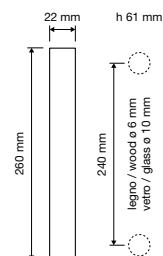
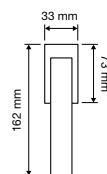
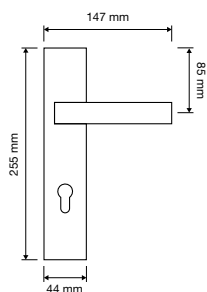
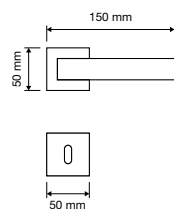
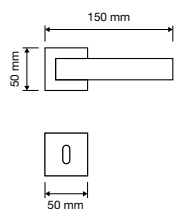

interassi disponibili / available distances
240 - 300 - 400 - 600 - 800

Slim Pelle

Il gioco di forme e volumi differenti dal sapore particolarmente moderno viene reso più classico grazie all'impugnatura rivestita in vera pelle italiana, naturale espressione della lavorazione artistica del pellame.

The combination of different forms and volumes with a particularly modern taste is made more classical in style thanks to the handgrip covered with real Italian leather, a natural expression of the artistic handcrafting of leather.

made in Italy

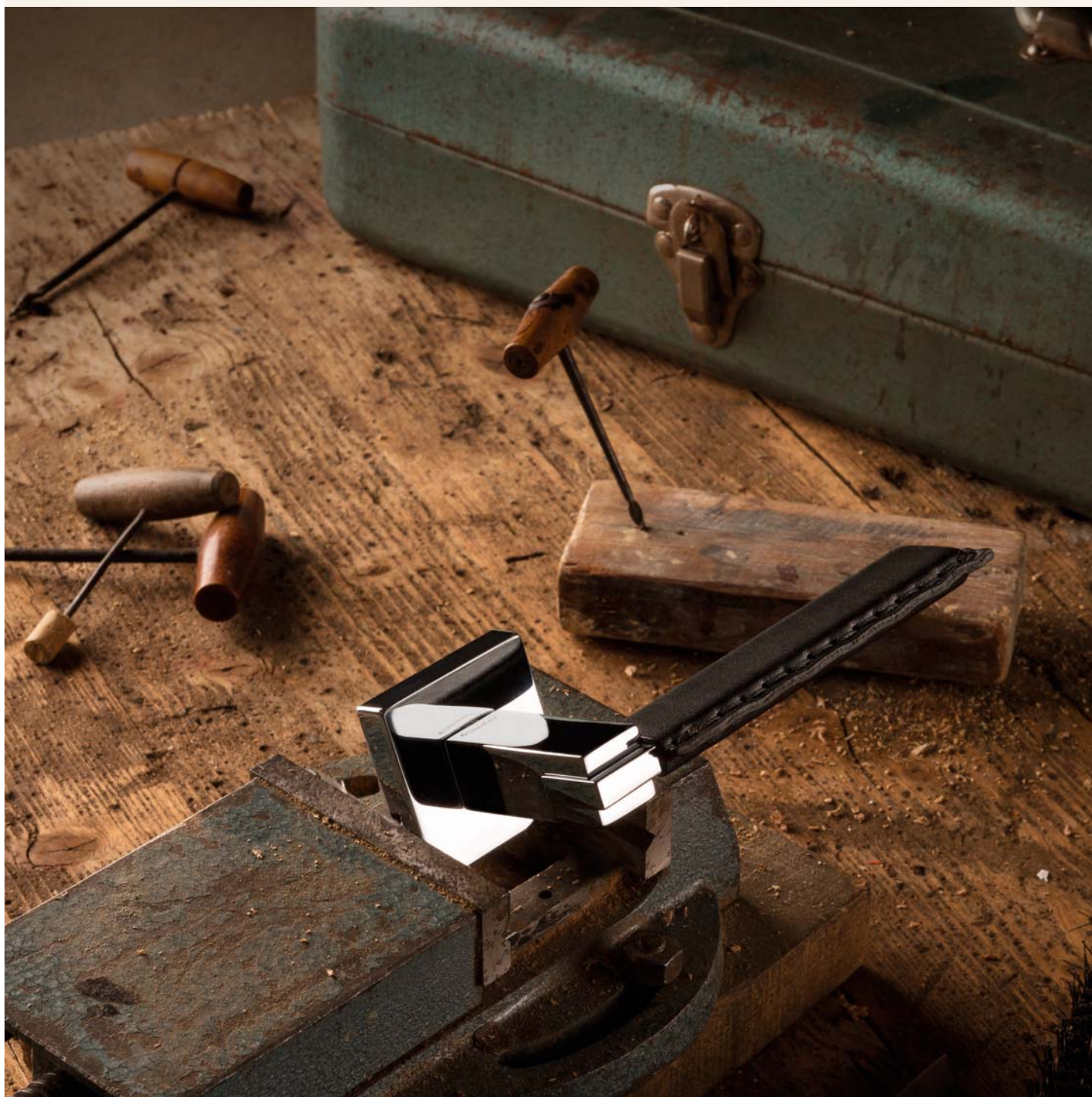



Cromo lucido
polished chrome
CR



Oro zecchino
gold plated
OZ

fantasie / fantasy



pelle nera
black leather
1111



pelle marrone
brown leather
1112

modelli / models



1111 RB 019

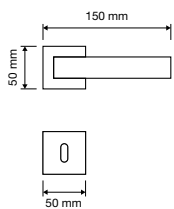

1111 RB 024

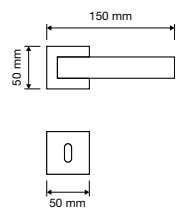

1111 PL

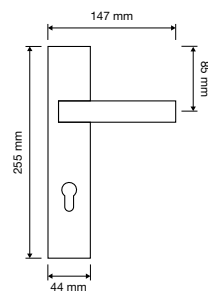

1111 SK

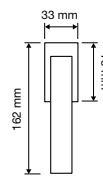

1111 MN 240

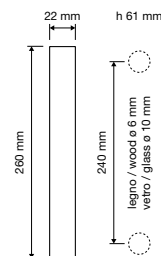

1111 MZ 240

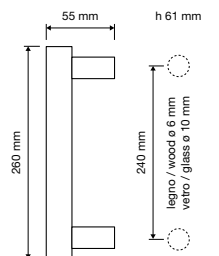

interassi disponibili / available distances
240 - 300 - 400 - 600 - 800

Spirit

Le forme audaci e seducenti di un fiore danno vita a questa collezione di maniglie particolarmente sexy e insolita.

The audacious and seductive forms of a flower give life to this particularly sexy and unusual collection of handles.

made in Italy | patented design

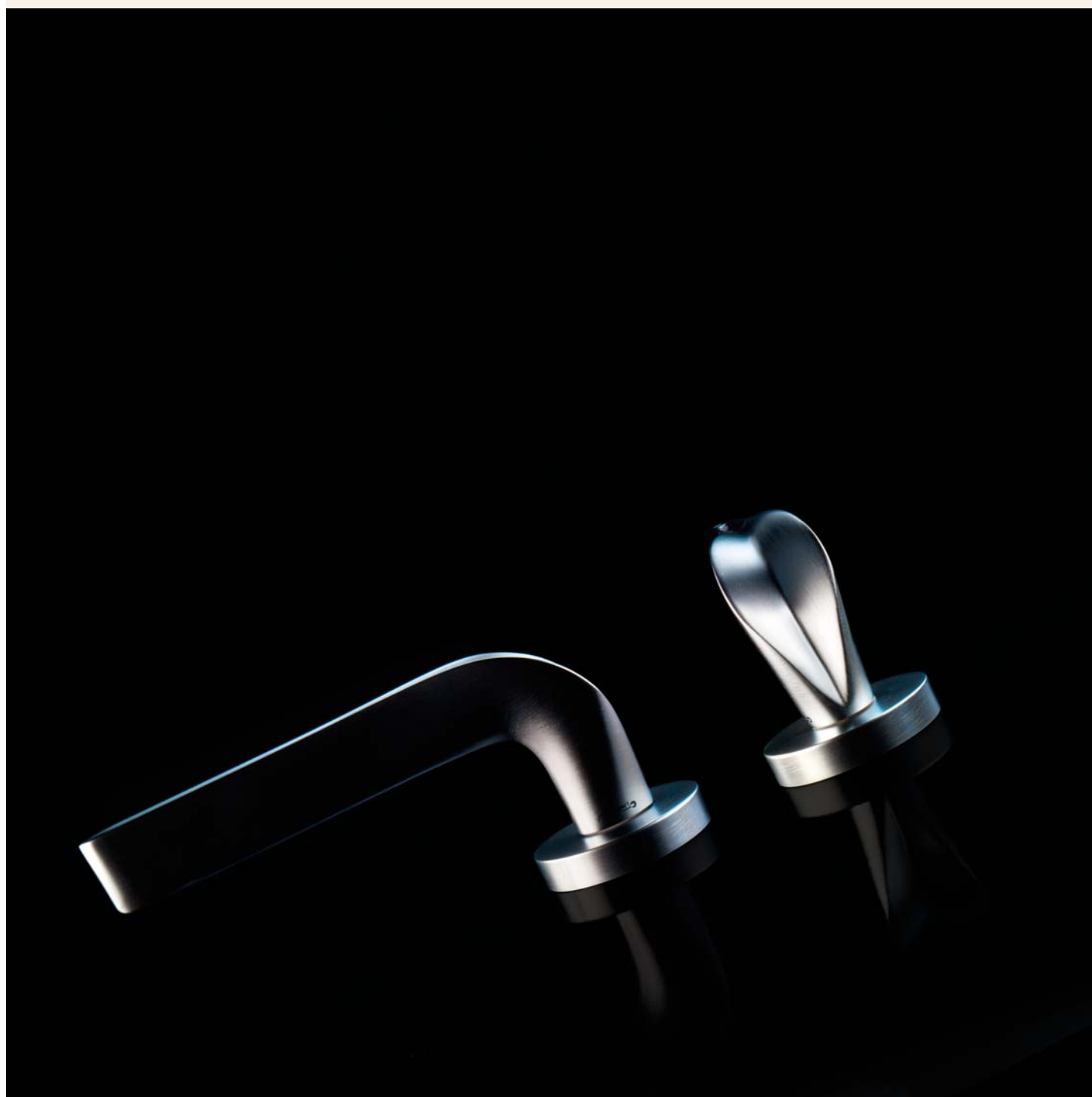



bronzo opaco
matt bronze
BM



cromo lucido
polished chrome
CR



cromo satinato
satin chrome
CS



oro zecchino
gold plated
OZ

modelli / models



1450 RB 023

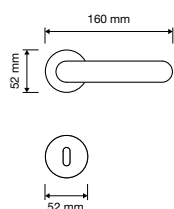

1450 RB 025

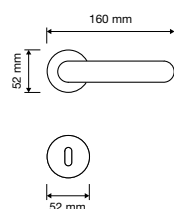

1454 PL

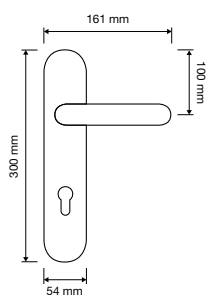

1450 SK

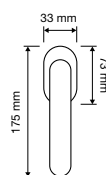

1450 MN 300

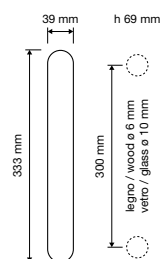

Strip

Una maniglia che si svela a ogni sguardo, con il suo insolito profilo ovale traslato che accoglie la mano con discrezione.

A handle that reveals itself at every glance with its unusual oval traversed profile that discreetly accommodates the hand.

made in Italy | patented design





Cromo lucido
polished chrome
CR



Cromo satinato
satin chrome
CS



Ottone lucido verniciato
polished brass
OL



Patiné
patiné matt
PM



Nero opaco
matt black
VE



1660 RB 023

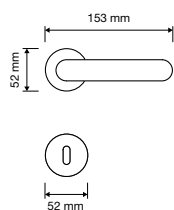

1660 RB 025

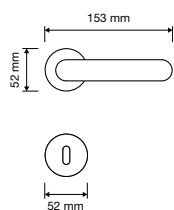

1660 PL

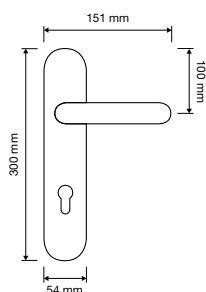

1660 SK

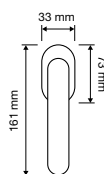

Thais

Una leggerissima scanalatura, appena percettibile agli occhi e sotto il palmo della mano, dona un sapore piacevolmente insolito a una collezione che fa della sua semplicità il suo punto di forza.

A very slight groove, barely visible to the eye and under the palm of the hand, gives a pleasantly unusual taste to a collection that makes its simplicity its strong point.

made in Italy





cromo satinato + cromo
satin chrome + polished chrome mix
CC



cromo lucido
polished chrome
CR



cromo satinato
satin chrome
CS



ottone satinato + ottone lucido
satin brass + polished brass mix
OT

modelli / models



1155 RB 019

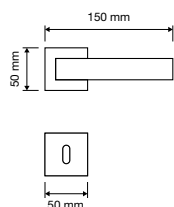

1155 RB 024

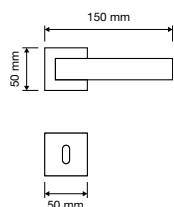

1155 RB 090

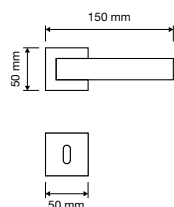

1155 SK

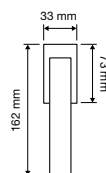

1155 MN 282

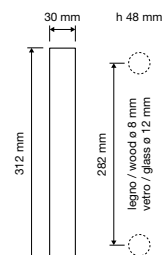

Wind

Il volume estroflesso dell'impugnatura crea un singolare effetto luce e rende questa collezione un piacevole punto di appoggio visivo su ogni tipologia di porta.

The extroflexed volume of the handgrip creates a unique light effect and makes this collection a pleasant visual support for every type of door.

made in Italy | patented design





Cromo lucido
polished chrome
CR



Cromo satinato
satin chrome
CS



Oro zecchino
gold plated
OZ



Patiné
patiné mat
PM

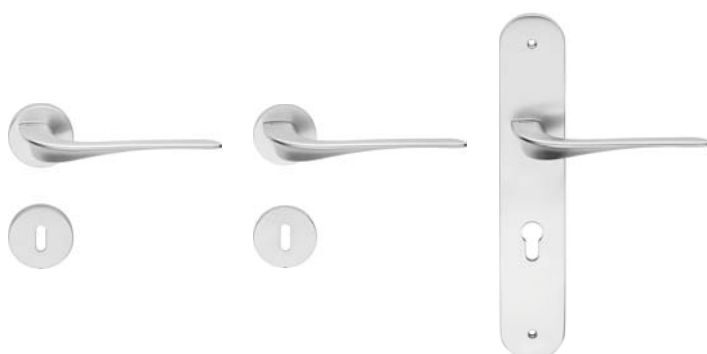

1655 RB 023

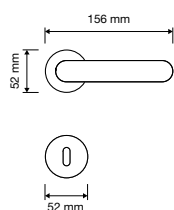

1655 RB 025

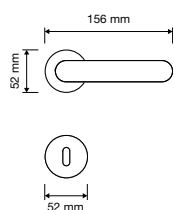

1655 PL

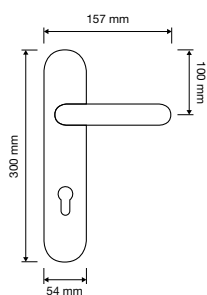

1655 SK

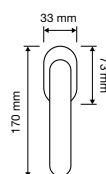

Zen

L'espressione del design moderno più classico e lineare è alla base del concept stilistico di questa collezione che si contraddistingue per l'estrema linearità delle forme.

An expression of a more classic and linear modern design is the basis for the style concept of this collection that stands out by the extremely linear forms.

made in Italy

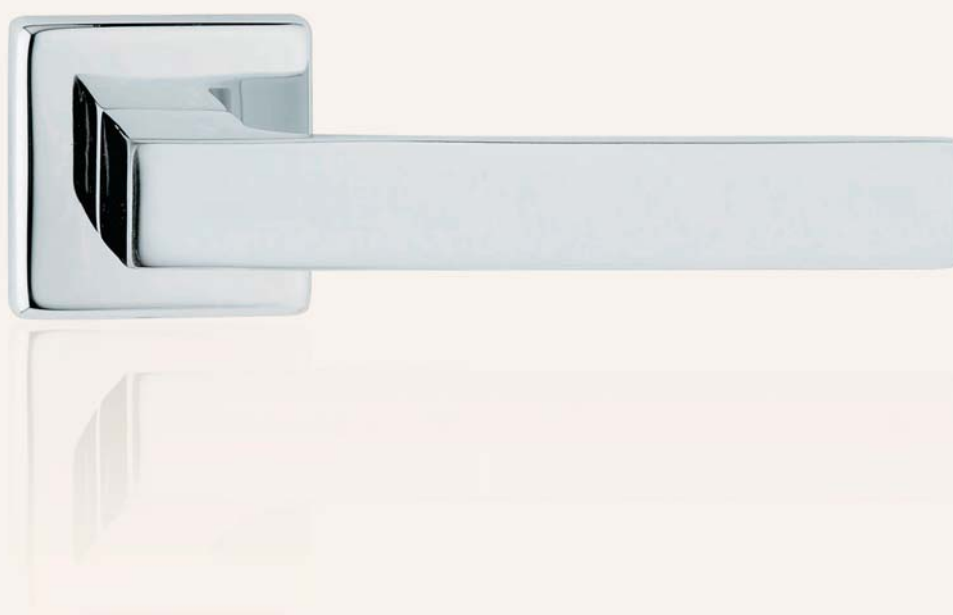



Cromo lucido
polished chrome
CR



Cromo satinato
satin chrome
CS



Ottone lucido verniciato
polished brass
OL

modelli / models



1156 RB 019

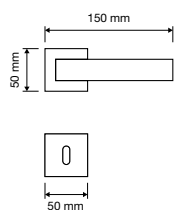

1156 RB 024

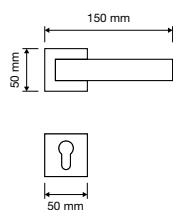

1156 RB 090

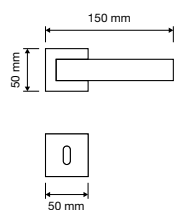

1153 PL

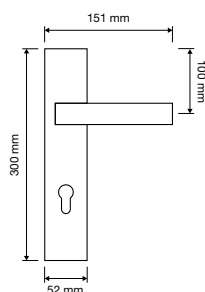

1156 MN 180

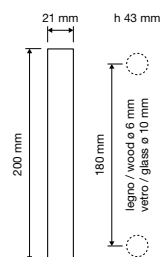

1156 MN 282

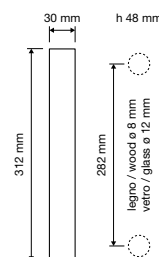

1156 SK

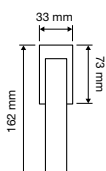

1156 AB

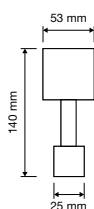

301 FE

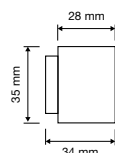

Zen Fusion

Due correnti stilistiche, il moderno e lo stile classico più autentico, dialogano e si fondono dando vita a un oggetto che ridefinisce il concetto di contemporaneità.

Two stylistic currents, one modern and the other authentic classic, communicate and blend together giving life to an object that redefines the concept of modernity.

made in Italy





cromo satinato + cromo lucido
satin chrome + polished chrome mix
CC



nero opaco + cromo
matt black + polished chrome mix
CE



cromo lucido + oro zecchino
polished chrome + gold plated
CZ



bronzo opaco + patiné
matt bronze + patiné
NP

modelli / models



1585 RB 019

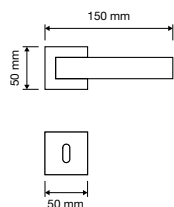

1585 RB 024

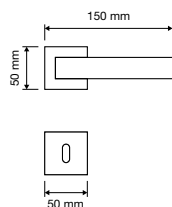

1585 PL

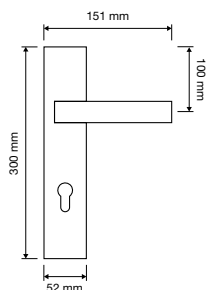

1585 SK

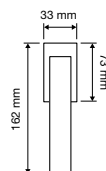

Zen Wengé

La difficile arte della semplicità è descritta nelle linee di questa collezione, impreziosita da un inserto in pregiato legno wengé.

The difficult art of simplicity is described in the lines of this collection, enhanced with an inlay in fine wenge wood.

made in Italy





Cromo lucido
polished chrome
CR



Cromo satinato
satin chrome
CS



Oro zecchino
gold plated
OZ

modelli / models



1158 RB 019

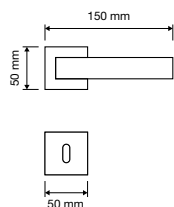

1158 RB 024

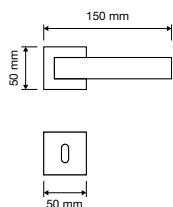

1152 PL

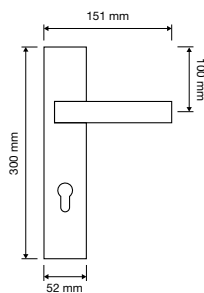

1158 SK

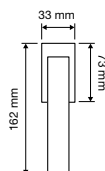

1158 MN 282

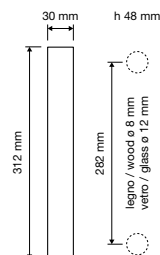

classic handles

classico

Aldar

Le forme morbide e gentili di questa collezione donano un tocco classico e piacevolmente femminile ad ogni ambiente.

The soft and gentle forms of this collection give a classical and pleasantly feminine touch to all surroundings.

made in Italy





ottone invecchiato
aged brass
AN



ottone bronzato graffiato
bronzed brass
OG



ottone lucido verniciato
polished brass
OL



oro + oro sabbato
polished gold + matt gold mix
OM



920 RB 103

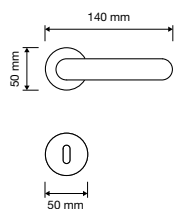

920 SK

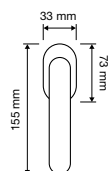

920 CR

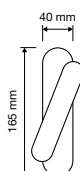

920 MN 218

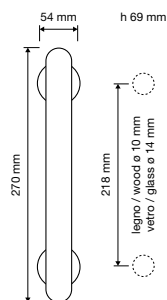

Aria

Uno statico blocco di ottone si trasforma in un oggetto caratterizzato da un'anima piacevolmente romantica e da un forte dinamismo delle linee.

A static piece of brass is transformed into an object characterised by a pleasantly romantic soul and dynamic lines.

made in Italy | patented design

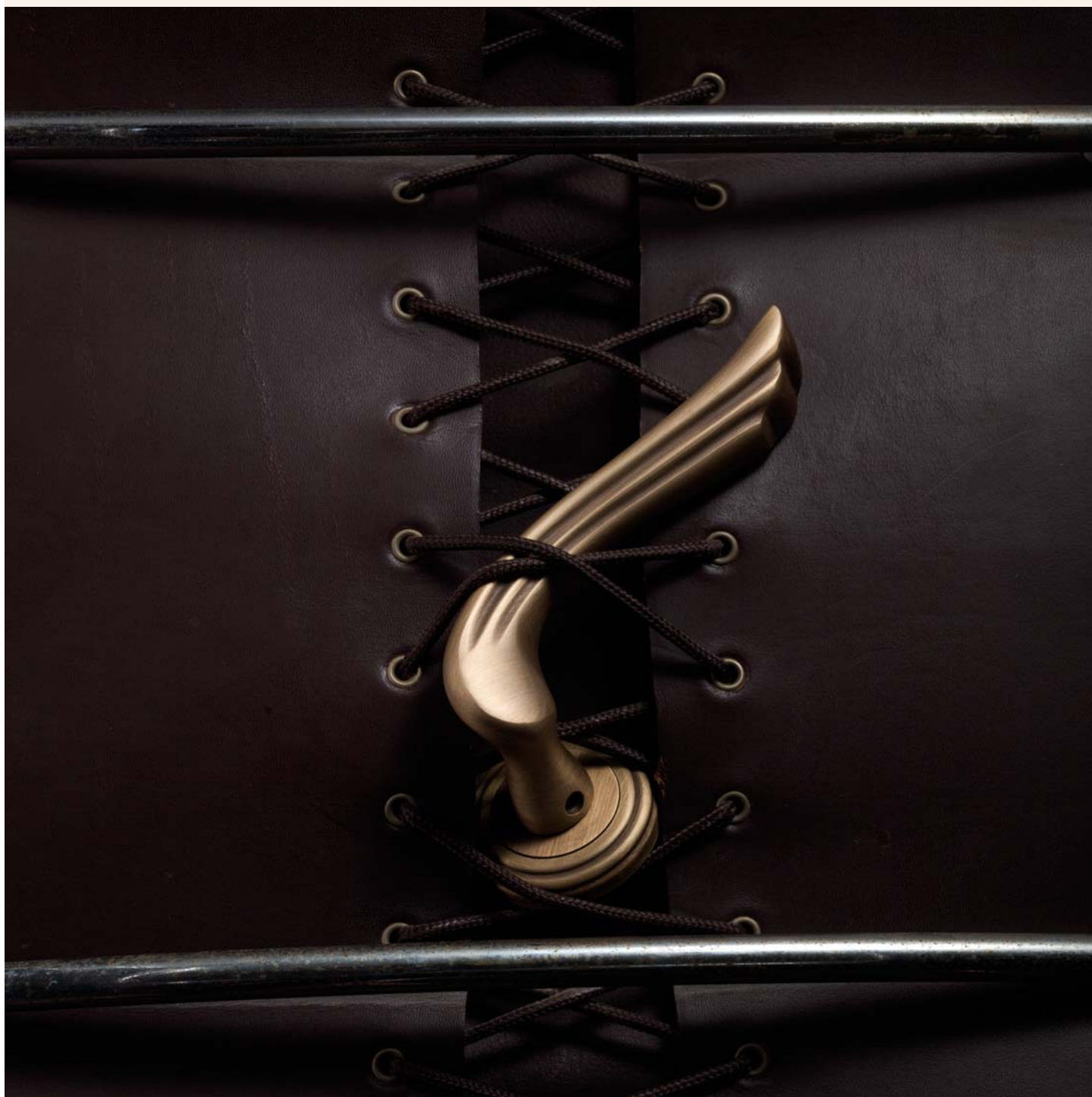



cromo lucido
polished chrome
CR



cromo satinato
satin chrome
CS



ottone lucido verniciato
polished brass
OL



oro zecchino
gold plated
OZ



patiné
patiné mat
PM



bronzo opaco
matt bronze
BM



1630 RB 011

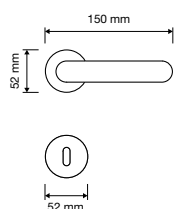

1630 PL

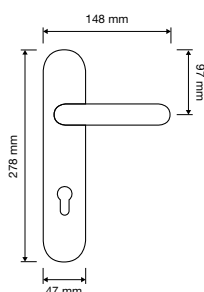

1630 SK

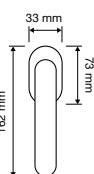

Beta

Il gusto semplice e "romantico" di un tempo è riletto in chiave moderna da questa collezione di maniglie contraddistinta da linee semplici e dolci.

The simple and "romantic" flavour of times gone by is reinterpreted in modern vein by this collection of handles distinguished by simple and soft lines.

made in Italy

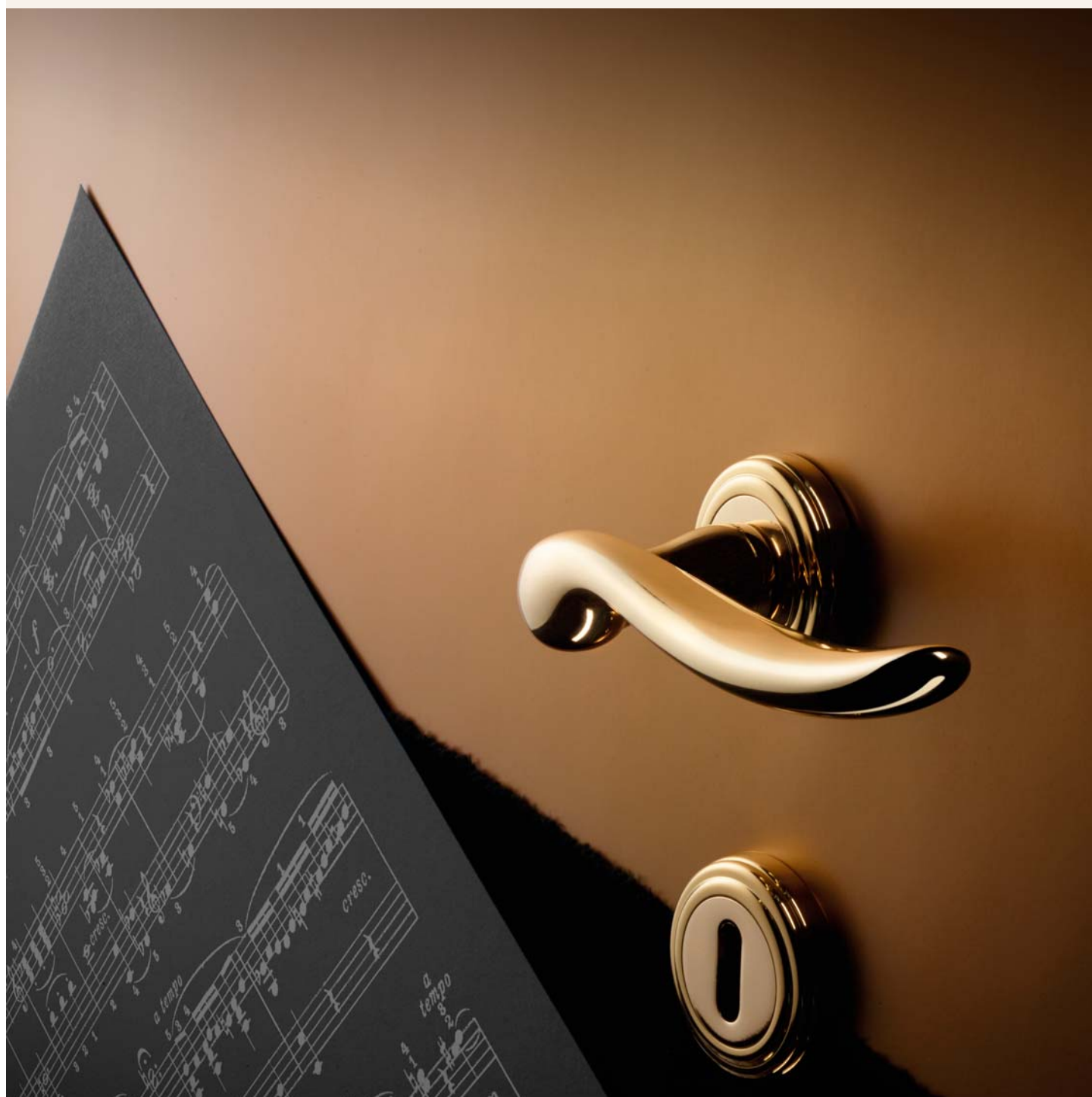



ottone invecchiato
aged brass
AN



cromo lucido
polished chrome
CR



cromo satinato
satin chrome
CS



ottone lucido verniciato
polished brass
OL



patiné
patiné mat
PM



488 RB 011

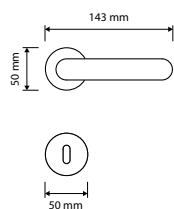

488 RB 101

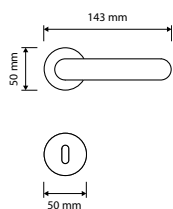

488 PL

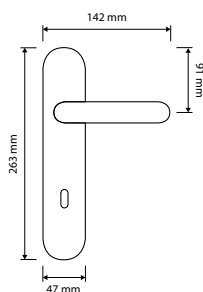

488 SK

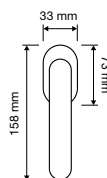

Dafne

La complessità del design si esplicita in una silhouette semplice ma insolita che ridefinisce il concetto di classico.

The complexity of the design is expressed in a simple yet unusual silhouette that redefines the concept of classic designs.

made in Italy





Cromo lucido
polished chrome
CR



Cromo satinato
satin chrome
CS



Ottone lucido verniciato
polished brass
OL



Patiné
patiné mat
PM



509 RB 019

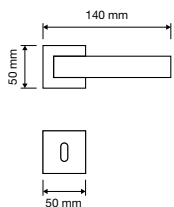

509 RB 024

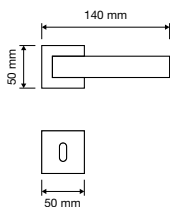

509 RB 102

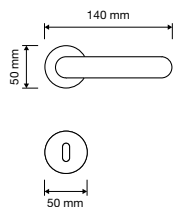

509 PL

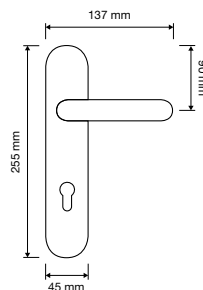

509 SK

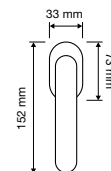

Dalia

Un viaggio oltre il tempo e le mode, un classico della maniglieria italiana che seduce con le sue forme classiche e gentili.

A journey beyond time and trends, a classic Italian handle that seduces with its classic and gentle shapes.

made in Italy





ottone invecchiato
aged brass
AN



bronzo opaco
matt bronze
BM



ferro effetto invecchiato
aged iron (brass)
FV



ottone bronzato graffiato
bronzed brass
OG



ottone lucido verniciato
polished brass
OL



porcellana bianca
white porcelain
PB 600



porcellana avorio
ivory porcelain
PA 602



porcellana bianca fiore rosa
pink rose flowered white porcelain
BR 660



porcellana avorio fiore rosa
pink rose flowered ivory porcelain
AR 766



porcellana bianca fiore blu
blue rose flowered white porcelain
BB 661



porcellana avorio fiore marrone
brown flowered ivory porcelain
AM 665



porcellana maculata
spotted porcelain
PAMAC 605



porcellana denim
denim porcelain
DENIM 606



600 RB 102

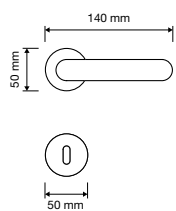

600 PL

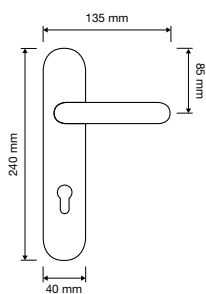

600 SK 

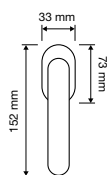

600 MX

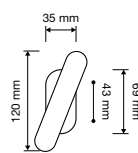

600 CR

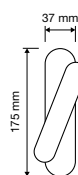

600 MN 218

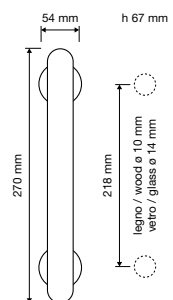

Delfino

Linee fluide scivolano fra le dita e danno vita a una forma particolare che discende dall'ambiente marino e che suscita curiosità.

Flowing lines glide beneath our fingers and give life to a particular shape that originates in the marine environment and arouses our curiosity.

made in Italy





bronzopaco
matt bronze
BM



chromo satinato
satin chrome
CS



chromo + chromo sabbato
chrome + matt chrome mix
MC



ottone lucido verniciato
polished brass
OL



oro + oro sabbato
polished gold + matt gold mix
OM



955 RB 102

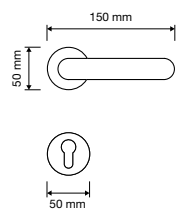

955 PL

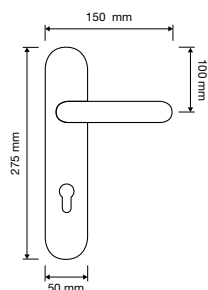

955 SK

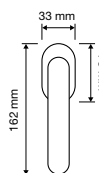

955 CR

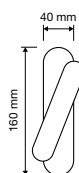

955 PT

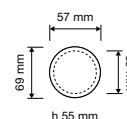

955 PG 102

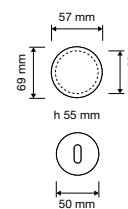



955 MN 240



542 CH

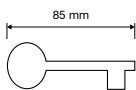
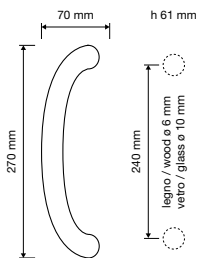

Elika

Linee sfuggenti donano un'inaspettata dinamicità a questa collezione, resa ancor più attraente dall'abbinamento insolito delle finiture che ne esaltano la forma.

Elusive lines give this collection an unexpected vitality, made even more attractive by the unusual combination of finishes that enhance the shape.

made in Italy





bronzo opaco
matt bronze
BM



cromo + cromo sabbato
chrome + matt chrome mix
MC



oro+oro sabbato
polished gold+matt gold
OM

modelli / models



990 RB 108

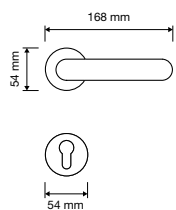

990 PL

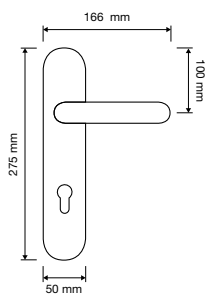

990 PT

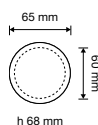

990 PG 108

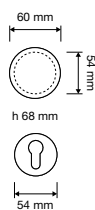

990 MN 275

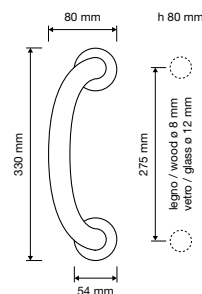

990 SK 

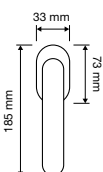

990 CR

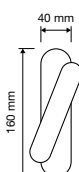

990 BA

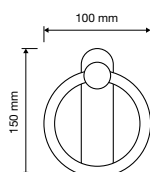

Erica

L'attualissimo stile shabby-chic, che combina il provenzale al british e retrò, vede come ideale complemento d'arredo questa collezione dalle forme piacevolmente femminili.

The recent shabby-chic style, that combines the Provencal style with the British retro style, makes this collection with pleasantly feminine forms the ideal furnishing accessory.

made in Italy





ottone invecchiato
aged brass
AN



bronzo opaco
matt bronze
BM



ottone bronzato graffiato
bronzed brass
OG



ottone lucido verniciato
polished brass
OL

fantasie / fantasy



porcellana bianca
white porcelain
PB 1295

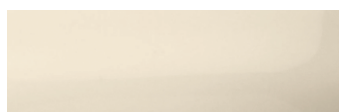

porcellana avorio
ivory porcelain
PA 1296

modelli / models



1295 RB 103

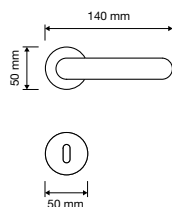

1295 PL

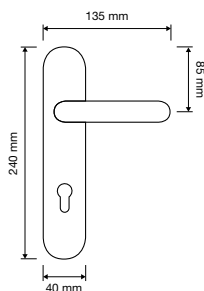

1295 SK

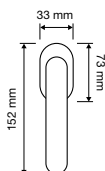

1295 MN 218

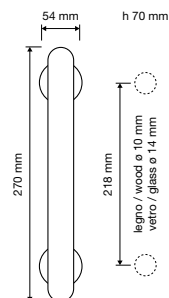

Flavia

Delicati e raffinati motivi floreali disegnano la pregiata porcellana italiana che caratterizza così questa collezione da un piacevole sapore retrò.

Delicate and refined floral motifs adorn this fine Italian porcelain that characterises this collection with a pleasantly retro taste.

made in Italy



finiture / finishing



ottone invecchiato
satin brass
AN



bronzo opaco
matt bronze
BM



ottone bronzato graffiato
bronzed brass
OG



ottone lucido verniciato
polished brass
OL

fantasie / fantasy



porcellana bianca
white porcelain
PB 685

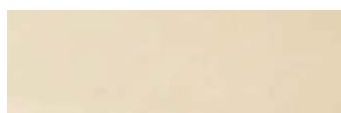

porcellana avorio
ivory porcelain
PA 687



porcellana bianca fiore rosa
pink rose flowered white porcelain
BR 680



porcellana avorio fiore rosa
pink rose flowered ivory porcelain
AR 767



porcellana bianca fiore blu
blue rose flowered white porcelain
BB 681



porcellana avorio fiore marrone
brown flowered ivory porcelain
AM 683



porcellana bianca margherita
daisy flowered white porcelain
PF 686

modelli / models



685 RO102

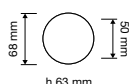

685 RB 102

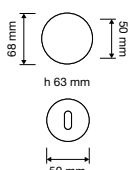

685 CR

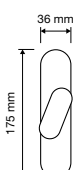

Florenzia

L'atmosfera delle vecchie dimore toscane, d'intonaci usurati e di vecchi pavimenti levigati dal tempo, è evocata da questa collezione dal piacevole sapore d'antan.

The atmosphere of old Tuscan farmhouses with faded plaster and floors that are polished from years of use is evoked by this collection with a pleasant taste of yesteryear.

made in Italy





ottone invecchiato
aged brass
AN



ferro effetto invecchiato
aged iron (brass)
FV



patiné
patiné mat
PM



ottone vibrato
vibrato brass
VB

modelli / models

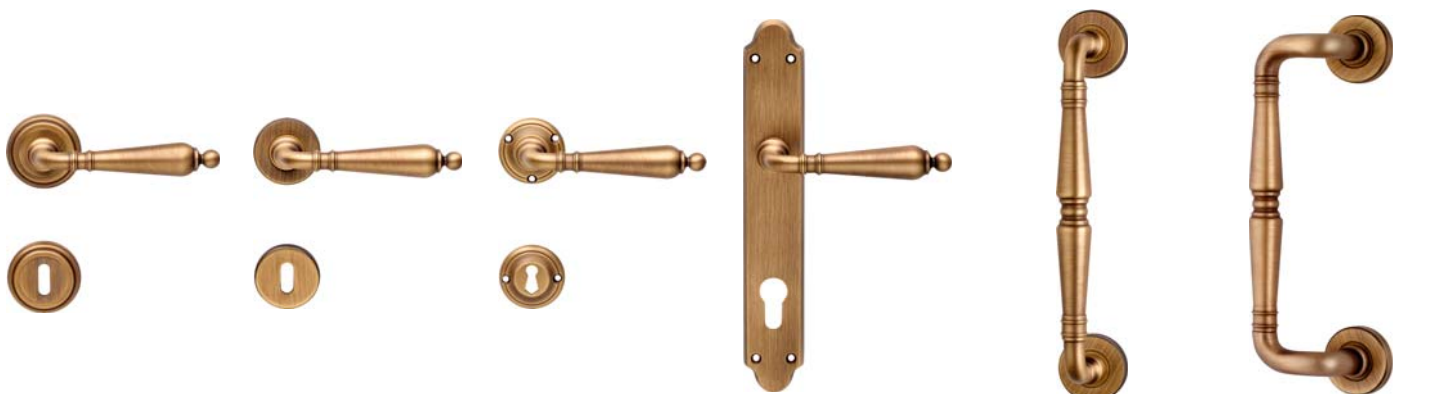

1460 RB 011

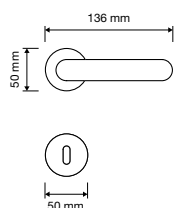

1460 RB 101

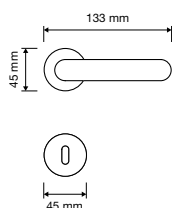

1460 RB 110

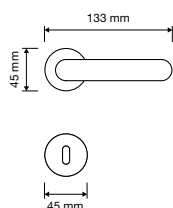

1460 PL

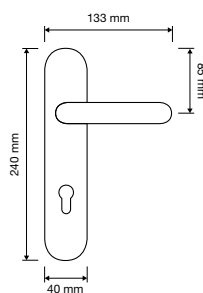

1460 MN 210

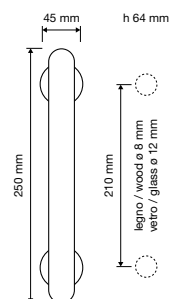

1460 MZ 198

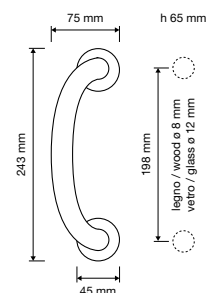

1460 SK

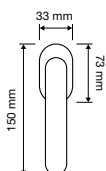

1460 CR

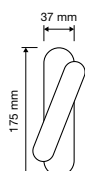

Havana

Linee curve si rincorrono dando vita a una silhouette estremamente dolce, caratterizzata da un alternarsi di superfici lucide e satinate, che vuole essere un omaggio al famosissimo sigaro cubano.

Curved lines follow one another giving life to an extremely sweet silhouette, characterized by alternating polished and satin surfaces, that is a tribute to the famous Cuban cigar.

made in Italy | patented design





Cromo lucido
polished chrome
CR



Ottone lucido verniciato
polished brass
OL



Oro + oro sabbato
polished gold + matt gold mix
OM



Oro zecchino
gold plated
OZ



1080 RB 102

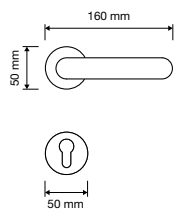

1080 PL

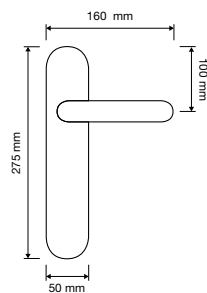

1080 SK 

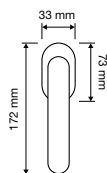

1080 MN 267

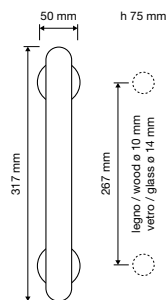

Heidi

L'amore per lo stile classico in voga nel '900 definisce le linee di questa elegante collezione di maniglie, nata con l'intento di completare l'interior design delle dimore più esclusive ed elitare.

The love for the classical style in vogue in the 1900s defines the lines of this elegant collection of handles, created with the aim of completing the interior design of the most exclusive and elite homes.

made in Italy





Cromo lucido
polished chrome
CR



Cromo satinato
satin chrome
CS



Ferro effetto invecchiato
aged iron (brass)
FV



Ottone lucido verniciato
polished brass
OL



Patiné
patiné mat
PM



Nero opaco
matt black
VE

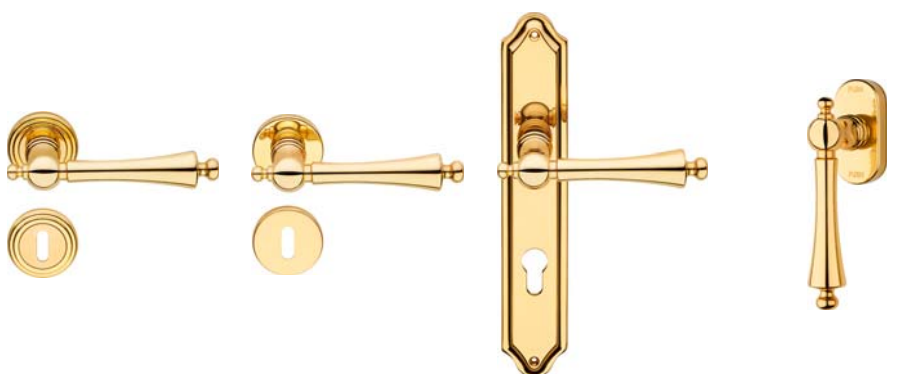

1665 RB 011

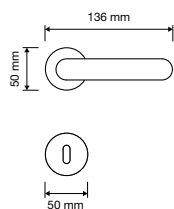

1665 RB 027

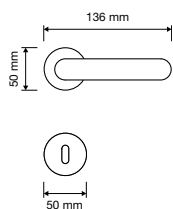

1665 PL

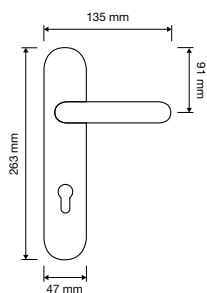

1665 SK 

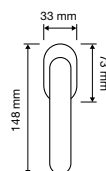

Karina

Gli stilemi del design anni '80 e le ardite finiture rendono questa collezione la scelta ideale in tutti quegli ambienti che necessitano di quel tocco in più che solo una maniglia di stile può dare.

The stylistic design of the 80s and the daring finishes make this collection the ideal choice in all environments that need that extra touch that only a stylish handle can give.

made in Italy





nero opaco + cromo
matt black + polished chrome mix
CE



nickel satinato + cromo
satin nickel + polished chrome mix
CN



ottone satinato + ottone lucido
satin brass + polished brass mix
OT

modelli / models



940 RB 102

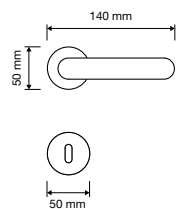

940 PL

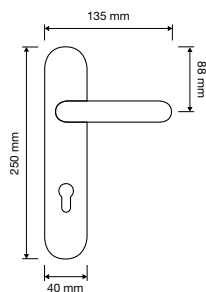

940 SK 

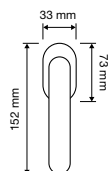

940 MN 203

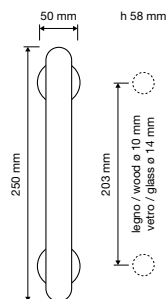

Kuba

Forme importanti, caratterizzate da linee morbide e dolci, rendono questa collezione insolita e facile da abbinare a ogni ambiente.

Imposing shapes, characterised by soft and gentle lines, make this an unusual and fun collection. An interesting and particular style.

made in Italy





Cromo lucido
polished chrome
CR



Cromo satinato
satin chrome
CS



Nickel satinato
satin nickel
NS



Ottone lucido verniciato
polished brass
OL



Oro zecchino
gold plated
OZ



930 RB 103

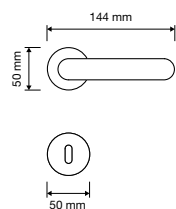

930 PL

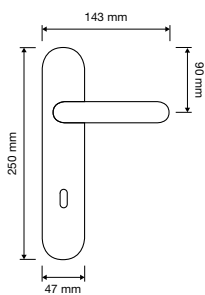

930 SK

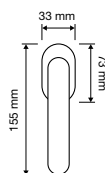

Kuba Pomolo

Una forma naturale, materica, che ricorda una pietra modellata dall'acqua e che risulta estremamente piacevole da impugnare.

A natural and material form, that recalls a stone that has been modelled by water and is extremely pleasant to hold.

made in Italy





cromo lucido
polished chrome
CR



cromo satinato
satin chrome
CS



nickel satinato
satin nickel
NS



ottone lucido verniciato
polished brass
OL



titanio
titanium
PV



936 RB 103

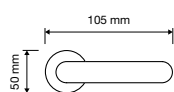

Lady

Una forma caratterizzata da linee dolci ed equilibrate, ispirate esplicitamente alla bellezza femminile.

A shape characterised by soft and balanced lines, inspired expressly by feminine beauty.

made in Italy | patented design

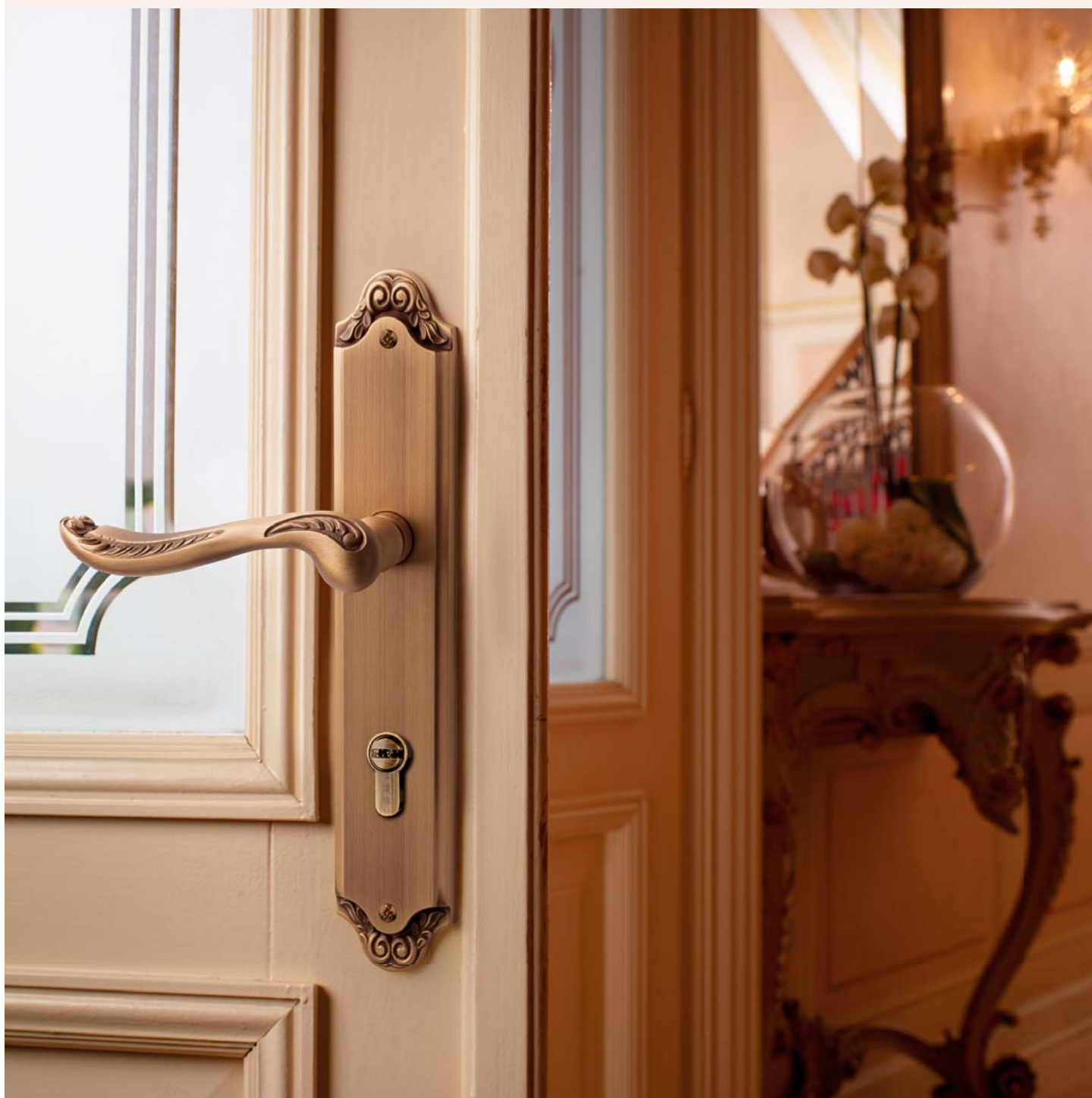



bronzo sfumato opaco
bronz
BO



oro francese
french gold
OF



ottone lucido verniciato
polished brass
OL



oro zecchino
gold plated
OZ

modelli / models



1390 RB 011

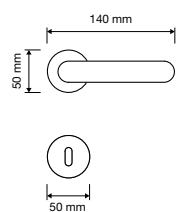

1390 PL

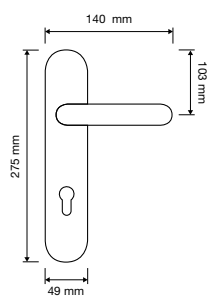

1390 SK 

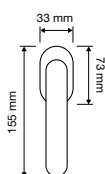

1390 SL



h 63 mm



1390 MN 155

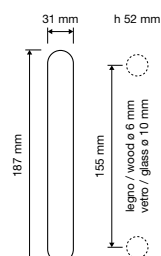

h 52 mm

legno / wood e 6 mm
vetro / glass e 10 mm

Libera

La sensazione di libertà è chiara ed evidente nelle forme che sembrano essere modellate dal vento.

The sensation of liberty is clear and evident in the forms that seem to have been shaped by the wind.

made in Italy





bronzo opaco
matt bronze
BM



nickel satinato
satin nickel
NS



ottone bronzato graffiato
bronzed brass
OG



ottone lucido verniciato
polished brass
OL



ottone satinato
satin brass
OS



981 RB 103

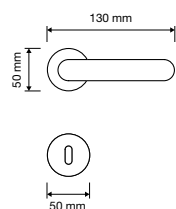

981 PL

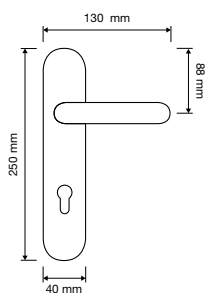

981 SK 

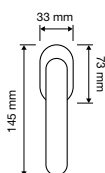

981 CR

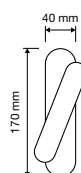

Marina

L'impugnatura stratificata movimentata il design di questa collezione dando vita a una silhouette classica ma piacevolmente originale.

The layered handle enlivens the design of this collection, giving life to a classic but pleasantly original silhouette.

made in Italy | patented design





bronzo opaco
matt bronze
BM



cromo lucido
polished chrome
CR



cromo satinato
satin chrome
CS



ottone lucido verniciato
polished brass
OL



patiné
patiné mat
PM



755 RB 102

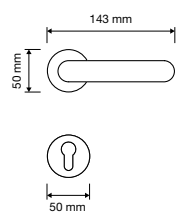

755 PL

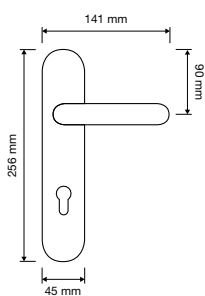

755 SK 

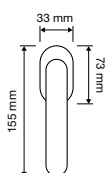

755 MN 320

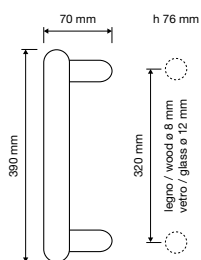

Moma

Inserti in vetro realizzati da sapienti artigiani rendono unica e inimitabile questa astratta collezione di maniglie.

Glass inserts created by skilled artisans make this abstract collection of handles unique and inimitable.

made in Italy





Cromo lucido
 polished chrome
 CR



Cromo satinato
 satin chrome
 CS



Oro zecchino
 gold plated
 OZ

fantasie / fantasy



1191



1192



1193



1195



1198



1201

modelli / models



1193 RB 102

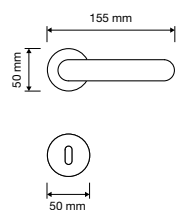

1253 PL

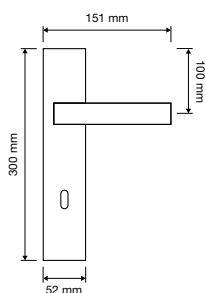

1193 SK

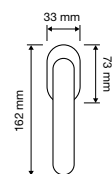

1193 CR

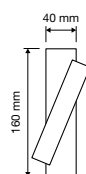

1193 MN 240

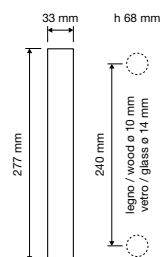

Nota

Una rilettura in chiave moderna di una melodia classica, caratterizzata dalla particolarissima impugnatura a forma di nota che rende questa collezione allegra e divertente.

A modern reinterpretation of a classic melody, characterized by the very unusual handgrip in the form of a musical note making this a cheerful and fun collection.

made in Italy | patented design





Cromo lucido
polished chrome
CR



Cromo satinato
satin chrome
CS



Ottone lucido verniciato
polished brass
OL



Patiné
patiné mat
PM



1330 RB 103

1330 PL



1330 SK 

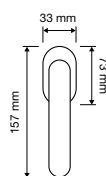
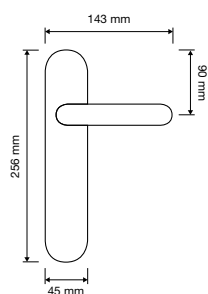
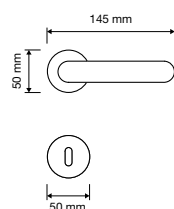

Pin-up

Le forme delle pin-up tanto in voga sulle riviste americane di un tempo, sono rievocate in questa particolare collezione quanto mai attuale.

The forms of the pin-up girls that were once so fashionable on American magazines are evoked in this particular and extremely modern collection.

made in Italy

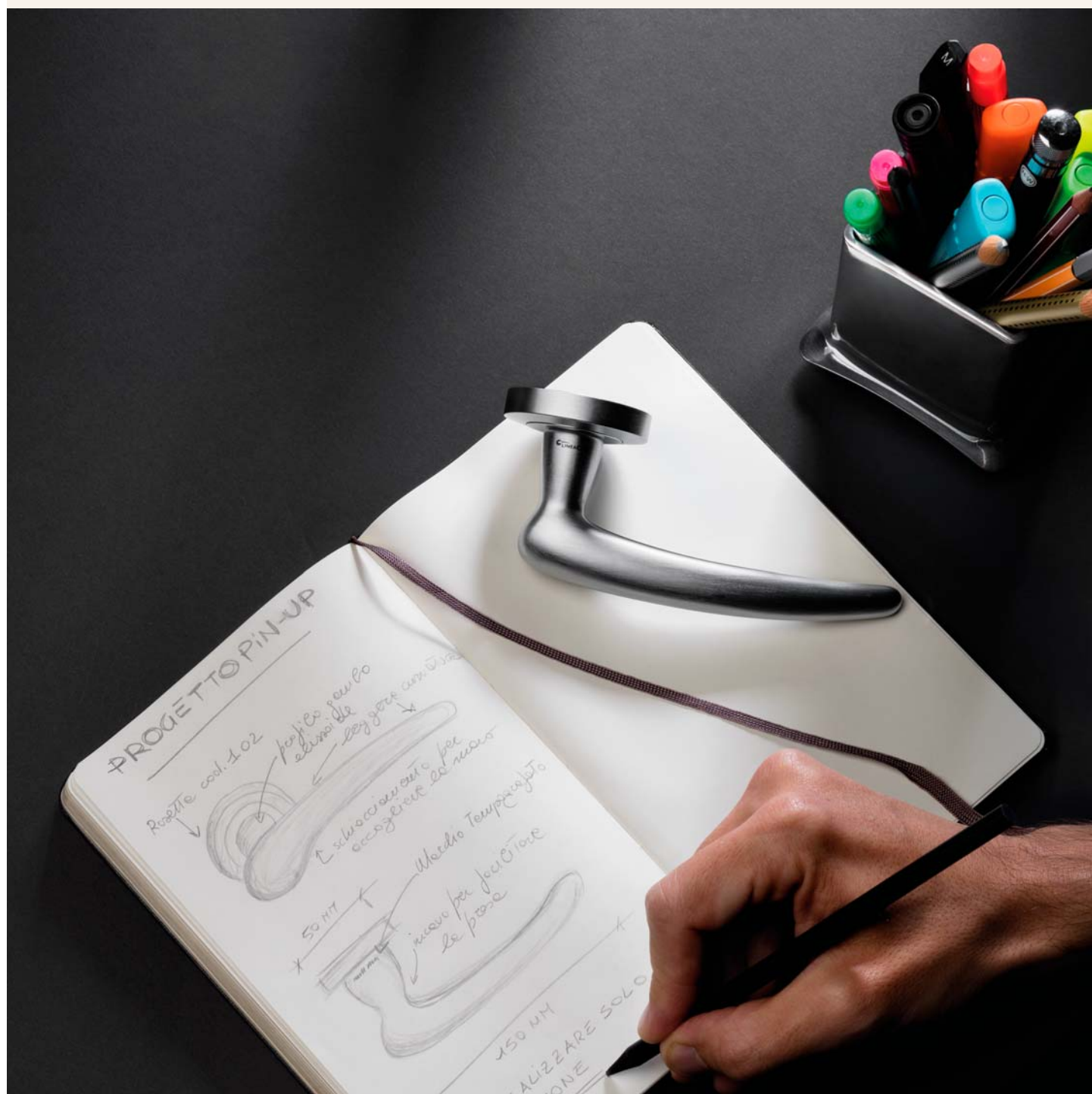



Cromo lucido
polished chrome
CR



Cromo satinato
satin chrome
CS



Nickel satinato
satin nickel
NS



Ottone lucido verniciato
polished brass
OL



Ottone satinato
satin brass
OS



925 RB 102

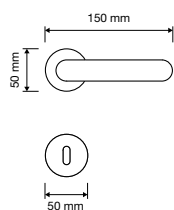

925 PL

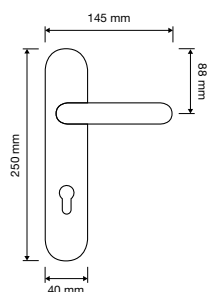

925 SK

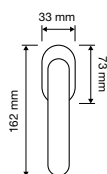

Profilo

Grazie al suo design senza tempo, Profilo si coordina con facilità a ogni ambiente e a ogni tipologia di porta, da quelle laccate a quelle in essenza.

Thanks to its timeless design, Profilo fits in easily with all environments and doors, from lacquered to natural wood doors.

made in Italy | patented design





cromo lucido
polished chrome
CR



cromo satinato
satin chrome
CS



cromo + cromo sabbato
satin chrome + polished chrome
MC



ottone lucido verniciato
polished brass
OL



oro + oro sabbato
polished gold + matt gold mix
OM



1040 RB 019

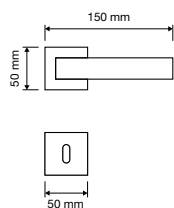

1040 RB 024

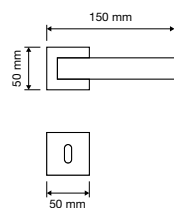

1040 RB 102

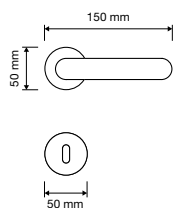

1040 PL

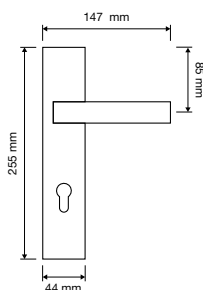

1040 SK

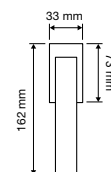

1040 CR

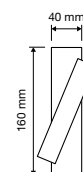



1042 PI

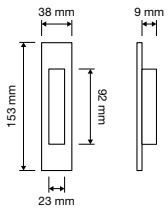

1040 MN 240

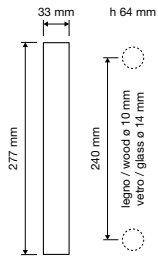

Relax

L'apoteosi del comfort. Particolari anelli "accolgono" le dita adattandosi ad ogni tipologia di mano.

Particular "rings" receive the fingers thus adapting itself to all types of hands.

made in Italy





chromo + chromo sabbato
chrome + matt chrome mix
MC 1003



oro zecchino + oro sabbato
gold plated + matt gold
OM 1001



oro zecchino + radica
gold plated + briarwood
OZ-RA 1013

modelli / models



1001 RB 108

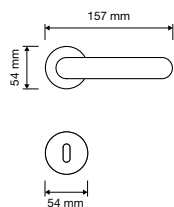

1001 PL

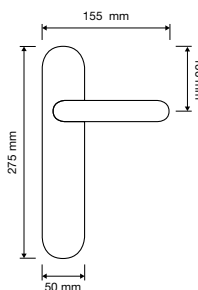

1001 SK 

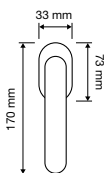

1001 CR

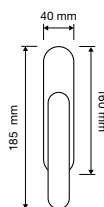

1001 MN 200

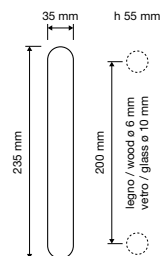

interassi disponibili /
available distances
150 - 200 - 250 - 300

Rose

Il "sapore" delicato e romantico della rosa Bonica regala un tocco di piacevole femminilità a questa collezione, ideale complemento d'arredo per tutti quegli ambienti dal sapore country e shabby-chic.

The dainty and romantic Bonica rose gives this collection a pleasant femininity, ideal furnishing accessory for all country and shabby-chic decors.

made in Italy





ottone invecchiato
aged brass
AN



bronzo opaco
matt bronze
BM



ferro effetto invecchiato
aged iron (brass)
FV



996 RB 108

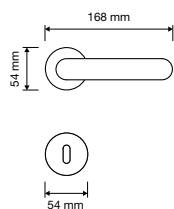

996 PL

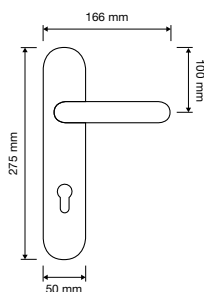

996 SK 

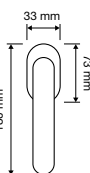

996 CR

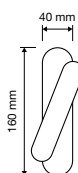

996 BA

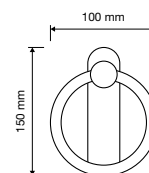



996 PB

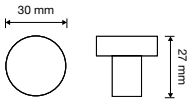

996 PT

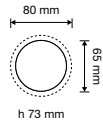

996 PG 108

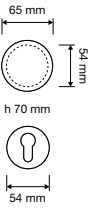

996 MN 275

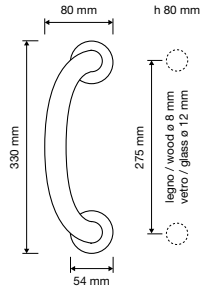

996 KD-KS

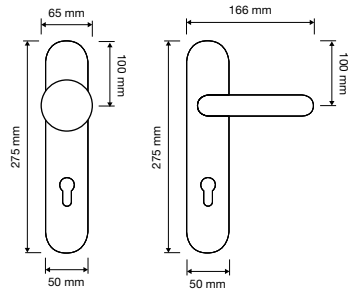

Tess

Una collezione estremamente contemporanea, classica ma che strizza l'occhio al design, caratterizzata da uno stile piacevolmente sobrio.

An extremely contemporary collection, classical while winking at design, characterised by a pleasantly sober style.

made in Italy





Cromo satinato + cromo
 satin chrome + polished chrome mix
 CC

Ottone satinato + ottone lucido
 satin brass + polished brass mix
 OT

modelli / models



511 RB 027

511 RB 102

511 RB 090

511 PL

511 SK 

511 CR

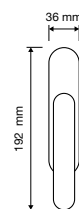
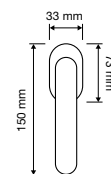
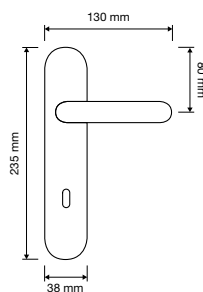
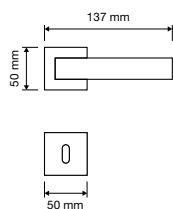
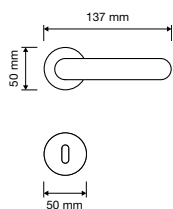
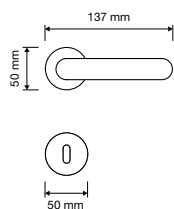

Tosca

Le atmosfere fresche ma allo stesso tempo sensuali dello stile provenzale, nato nella parte meridionale della Francia fra le Alpi e il mare, donano a questa collezione un "allure" particolarmente romantica.

The fresh but at the same time sensual atmosphere of the Provençal style, created in the south of France between the Alps and the sea, gives this collection a particularly romantic allure.

made in Italy





ottone invecchiato
aged brass
AN



bronzo opaco
matt bronze
BM



ferro effetto invecchiato
aged iron (brass)
FV



ottone lucido verniciato
polished brass
OL

modelli / models



745 RB 110

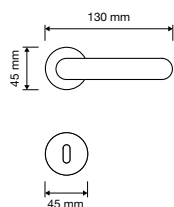

745 PL

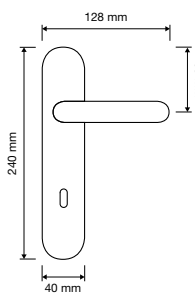

745 SK

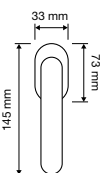

745 CR

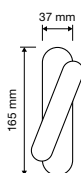

745 MN 158

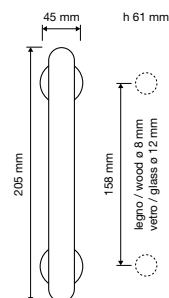

745 MN 225

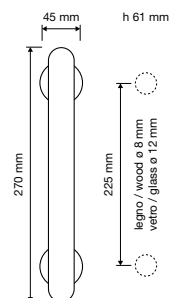

Trendy

La semplicità delle forme raggiunge l'espressione più elevata in questa collezione che si distingue per la sua estrema leggerezza del design, risultando così un complemento d'arredo passe-partout.

The simplicity of forms reaches its highest expression in this collection that is distinguished by the extreme lightness of its design, making it a passe-partout accessory.

made in Italy





Cromo lucido
polished chrome
CR



Cromo satinato
satin chrome
CS



Ottone lucido verniciato
polished brass
OL

modelli / models



980 RB 102

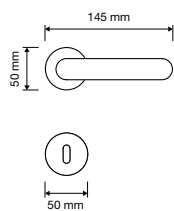

980 RB 019

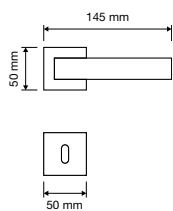

980 RB 024

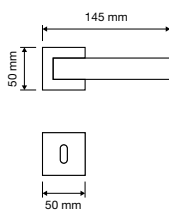
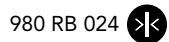

980 SK

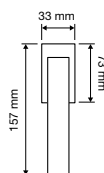

basic handles

basic

Brixia

La semplicità, rappresentata dall'impugnatura esile nel design ma sicura sotto la mano, rende questa collezione un complemento d'arredo estremamente semplice da abbinare.

Simplicity, represented by a handgrip which is slender in design yet firm under then hand, makes this collection a furnishing accessory that fits in everywhere with extreme ease.

made in Italy





Cromo lucido
polished chrome
CR



Cromo satinato
satin chrome
CS



Nickel satinato
satin nickel
NS



Ottone bronzato graffiato
bronzed brass
OG



Ottone lucido verniciato
polished brass
OL



Ottone satinato
satin brass
OS



760 RB 101

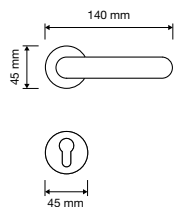

760 RB 102

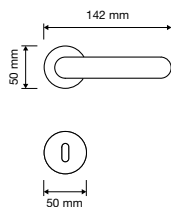

760 PL

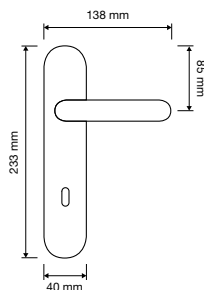

760 SK 

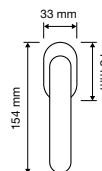

Garda

La semplicità è alla base di questa collezione, contraddistinta dall'impugnatura particolarmente arrotondata che trasmette una piacevole sensazione alla mano.

Simplicity is at the base of this collection, characterised by the particularly rounded handgrip that transmits a pleasant sensation to the hand.

made in Italy





Cromo lucido
polished chrome
CR



Cromo satinato
satin chrome
CS



Nickel satinato
satin nickel
NS



Ottone bronzato graffiato
bronzed brass
OG



Ottone lucido verniciato
polished brass
OL



Ottone satinato
satin brass
OS



670 RB 101

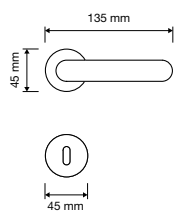

670 RB 096

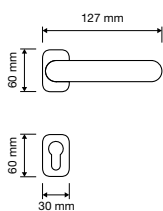

670 PL

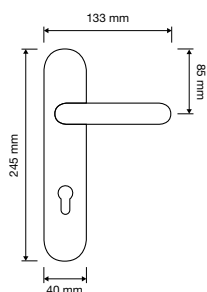

670 SK 

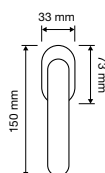

670 DK

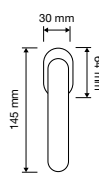

670 MX

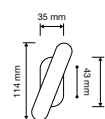



670 CR

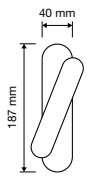

670 MN 200

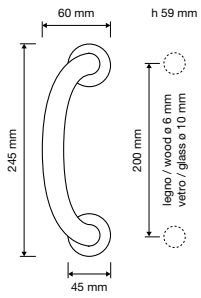

Ibiza

Il mare che bacia la spiaggia di Portinatx è stato l'ispirazione del design dell'impugnatura, modellata come un'onda e che dona un tocco molto personale ad ogni ambiente.

The sea that kisses the beach of Portinatx provided the inspiration for the design of the handgrip, modelled like a wave and which gives all rooms a personal touch.

made in Italy





ottone invecchiato
aged brass
AN



ferro effetto invecchiato
aged iron (brass)
FV



ottone bronzato graffiato
bronzed brass
OG



ottone lucido verniciato
polished brass
OL



545 RB 101

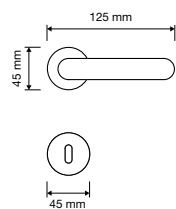

545 PL

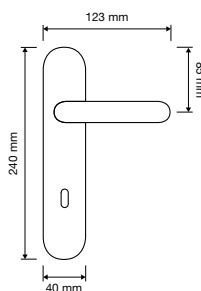

545 SK

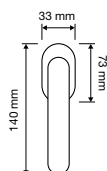

545 MX

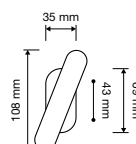

545 CR



Mare

Il mare dolce e calmo della baia di Lindos (Grecia) riaffiora alla mente guardando questa collezione elegante e discreta, contraddistinta dall'impugnatura spiovente.

The calm and sweet sea of the bay of Lindos (Greece) comes to mind when admiring this elegant and discreet collection, characterised by the sloping handgrip.

made in Italy





Cromo lucido
polished chrome
CR



Cromo satinato
satin chrome
CS



Ottone bronzato graffiato
bronzed brass
OG



Ottone lucido verniciato
polished brass
OL



Ottone satinato
satin brass
OS



710 RB 101

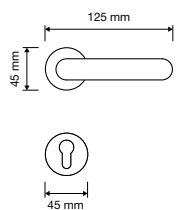

710 PL

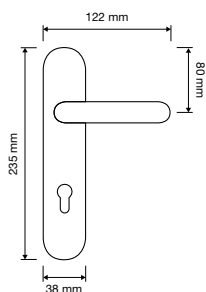

710 SK

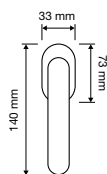

710 CR

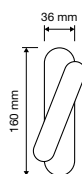

Onda

Ispirata alle onde e bellezze del Lago di Garda, è contraddistinta dal particolare incavo dell'impugnatura che le dona una presa estremamente sicura e comoda.

Inspired by the waves and beauty of Lake Garda, it is distinguished by the particular recess of the handgrip that gives it an extremely firm and comfortable grasp.

made in Italy





bronzo opaco
matt bronze
BM



ottone bronzato graffiato
bronzed brass
OG



ottone lucido verniciato
polished brass
OL



ottone satinato
satin brass
OS



530 RB 101

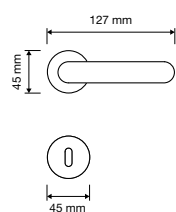

530 RB 103

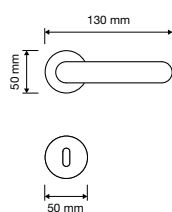

530 PL

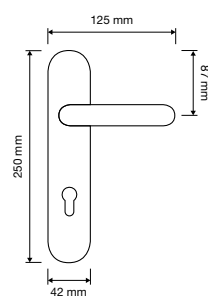

530 SK 

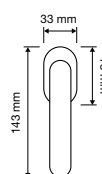

530 CR

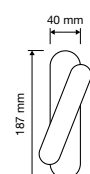

Piuma

Le cose semplici sono le più difficili da progettare, ma quando ci si riesce il risultato è notevole; così è stato per questa collezione, caratterizzata da linee armoniose che la rendono apparentemente esile ma che consentono una presa sicura e confortevole.

The simplest things are the most difficult to design, but when you succeed the result is striking; so it was for this collection, characterised by harmonious lines that make it seem slight but allow for a firm and comfortable grip.

made in Italy





Cromo lucido
polished chrome
CR



Cromo satinato
satin chrome
CS



Ottone bronzato graffiato
bronzed brass
OG



Ottone lucido verniciato
polished brass
OL



1415 RB 101

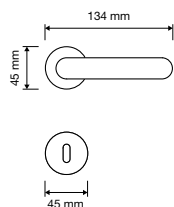

1415 RB 096

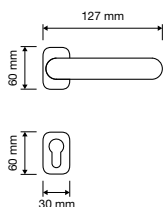

1415 PL

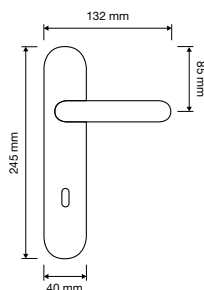

1415 SK

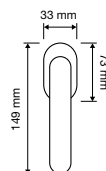

vintage handles

vintage

Aida

L'anima spensierata e fantasiosa dello stile Luigi XV si riflette in questa elegante collezione di maniglie che nasce con l'intento di valorizzare ambienti arredati in stile classico particolarmente preziosi.

The carefree and imaginative soul of the Louis XV style is reflected in this elegant collection of handles that was created with the intention of enhancing particularly precious classically furnished rooms.

made in Italy | patented design

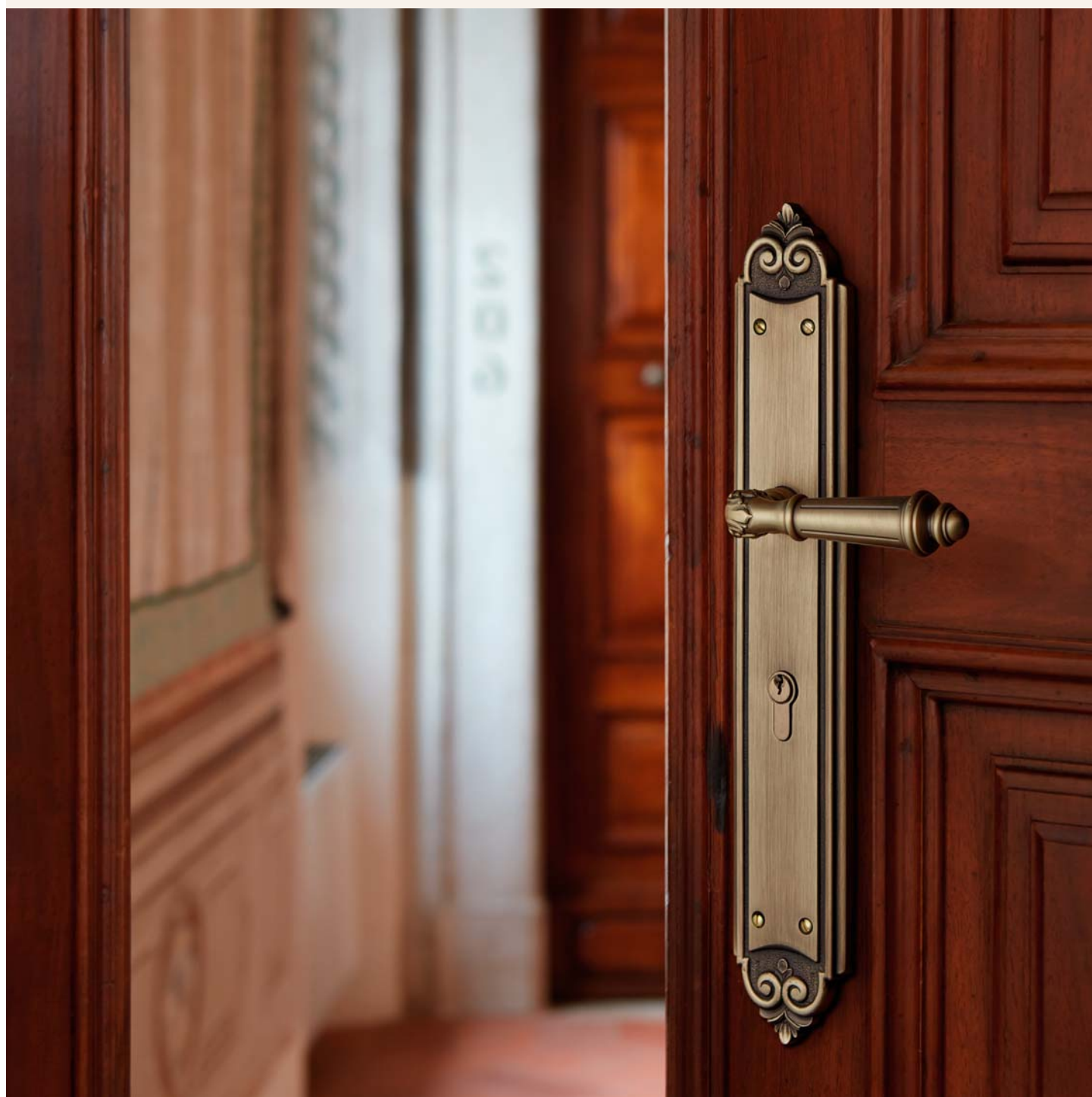



nero francese
french black
NF



oro francese
french gold
OF



oro zecchino
gold plated
OZ



patiné
patiné mat
PM



1610 RB 005

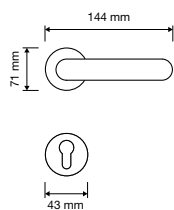

1611 PL

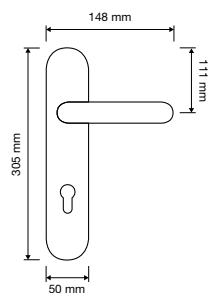

1610 PL

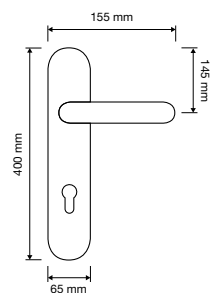

1610 MN 172

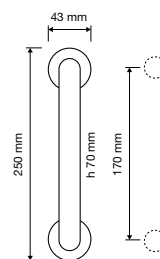

1610 SL

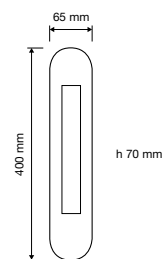

Aisha

Le geometrie dell'architettura araba rife-
riscono in questa armoniosa collezione,
dove il collo della maniglia si sviluppa
come un fiore che si schiude e un grande
petalo forma l'impugnatura vera e propria.

The geometry of Arabic architecture is
brought back to life in this harmonious
collection, where the neck of the handle
develops like a flower opening and a large
petal forms the handgrip itself.

made in Italy | patented design

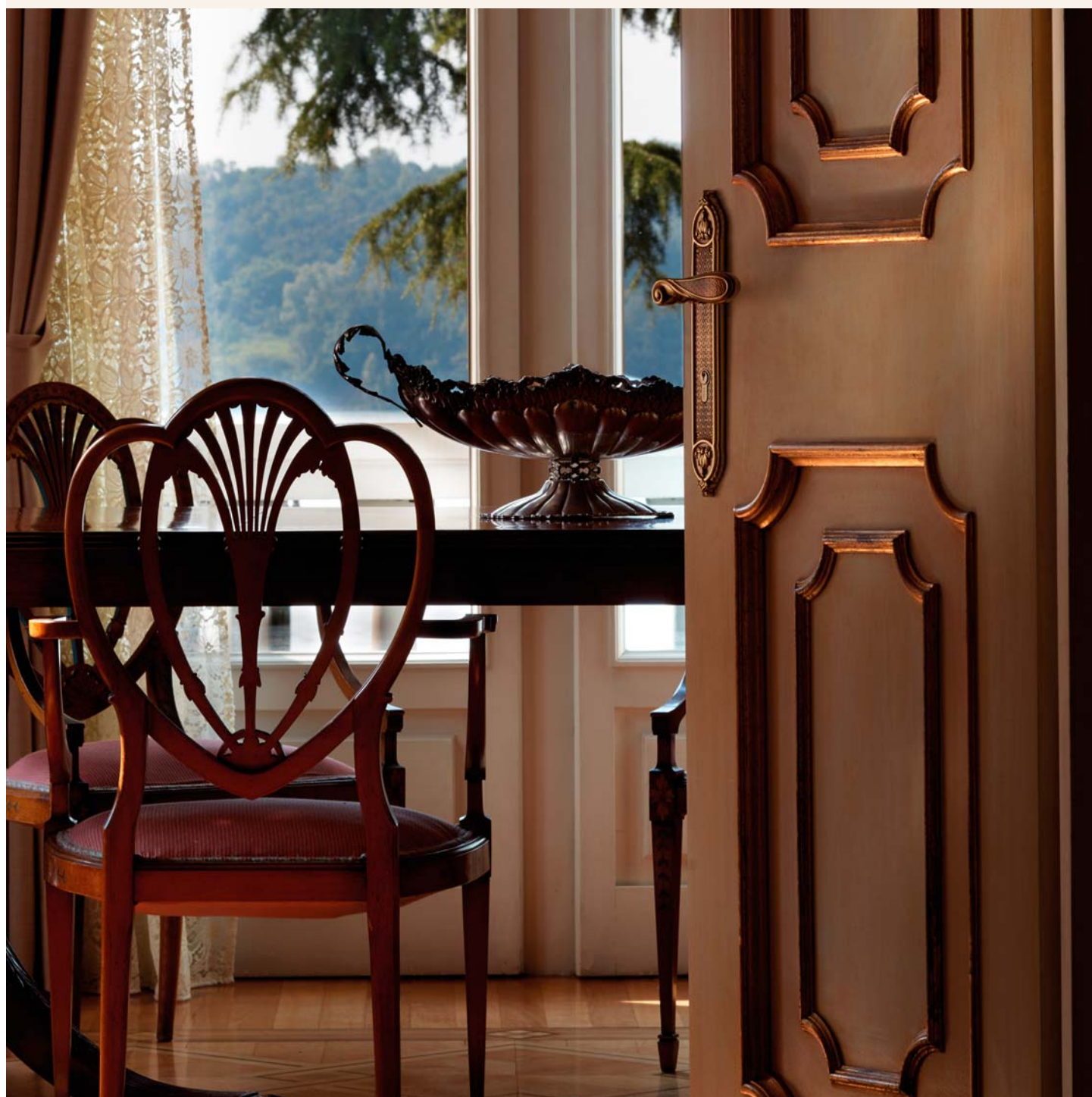



nero francese
french black
NF



oro francese
french gold
OF



oro zecchino
gold plated
OZ



patiné
patiné mat
PM

modelli / models

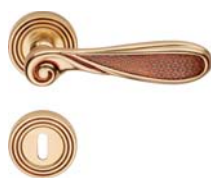

1650 RB 112

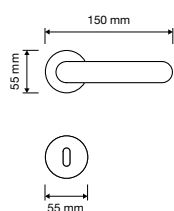

1650 RB 115

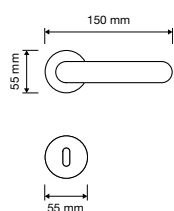

1650 PL

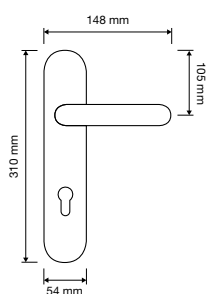

1651 PL

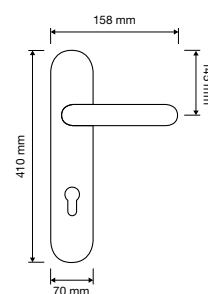

1650 PT

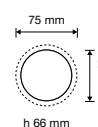

1651 FP

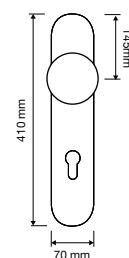



1650 SL



1651 SL

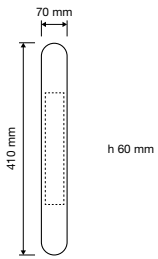
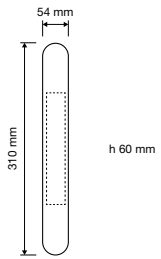

Arcadia

Una sontuosa ghirlanda adorna questa maniglia che catalizza l'attenzione con le sue forme ricercate ed eleganti.

A sumptuous garland adorns this handles that captures our attention with its refined and elegant shapes.

made in Italy | patented design

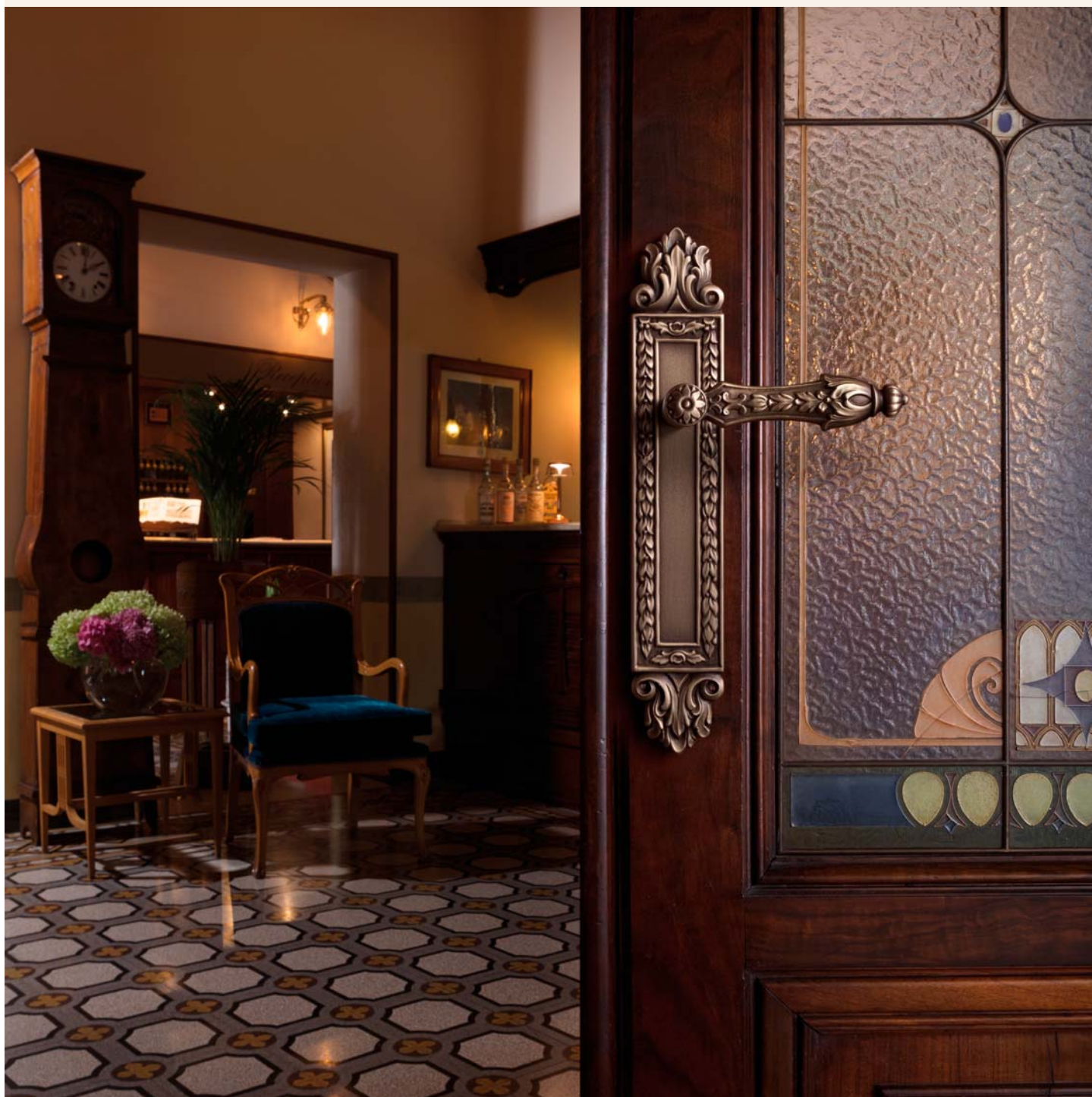



oro francese
french gold
OF



oro zecchino
gold plated
OZ



nero francese
french black
NF



patiné
patiné mat
PM



1640 RB 008

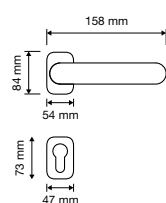

1640 RB 113

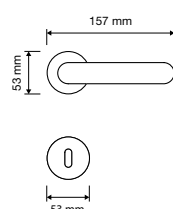

1640 PL

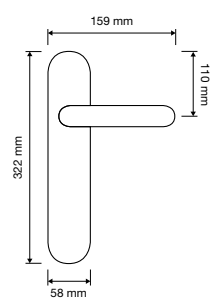

1641 PL

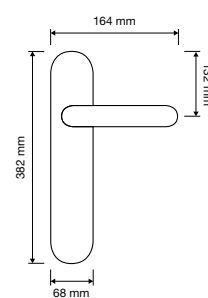

Arte

Un bellissimo fiore dona grazia e maestosità a questa collezione Liberty ispirata alle opere di Alfons Mucha, pittore e scultore ceco che fu uno dei più importanti artisti dell'Art Nouveau.

A beautiful flower gives grace and majesty to this Liberty collection inspired by the works of Alfons Mucha, a Czech painter and sculptor, one of most important Art Nouveau artists.

made in Italy | patented design

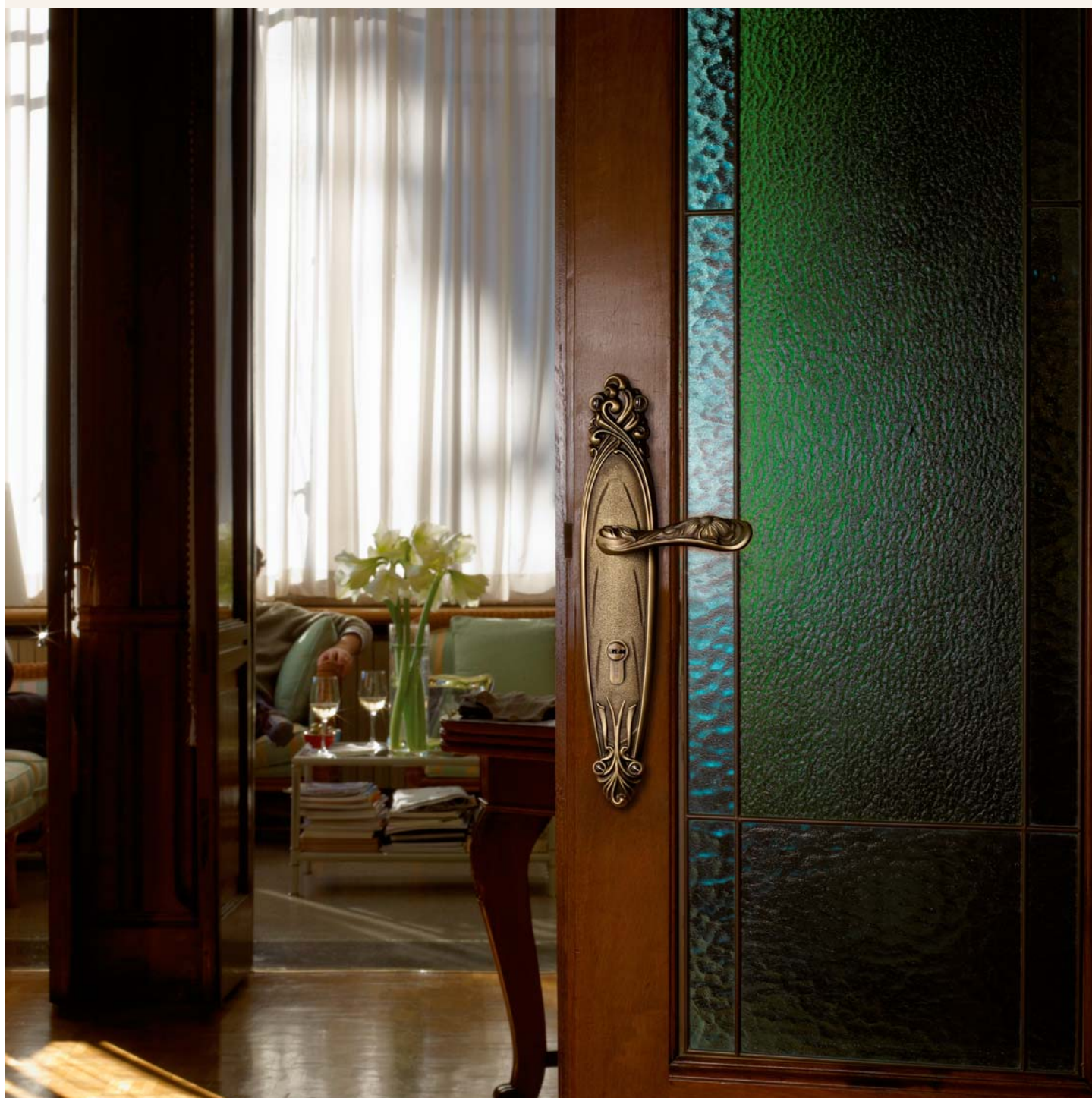



oro francese
french gold
OF



oro zecchino
gold plated
OZ



patiné
patiné mat
PM

modelli / models



1165 RB 091

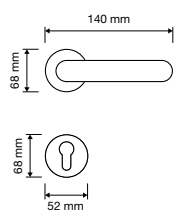

1165 RB 113

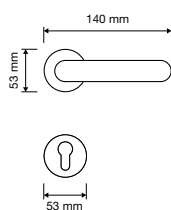

1165 PL

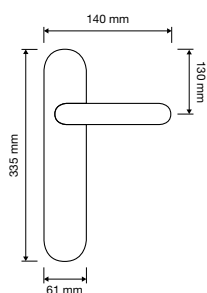

1165 DK

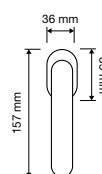

1165 MN 796

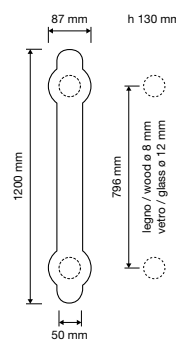

interassi disponibili /
available distances
596 - 796 - 896 - 1196

Barocco

Una collezione che meraviglia per la sua ricercatezza, frutto delle sapienti mani di artigiani italiani che trasformano un semplice pezzo di ottone in un prezioso accessorio d'arredo.

A collection that delights us with its panache, the results of the skilful hands of Italian artisans that transform a simple piece of brass into a precious furnishing accessory.

made in Italy | patented design





oro francese
french gold
OF



oro zecchino
gold plated
OZ



patiné
patiné mat
PM

modelli / models



1520 RB 015

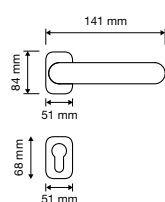

1520 RB 113

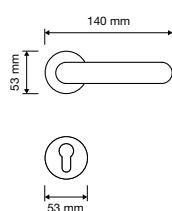

1520 PL

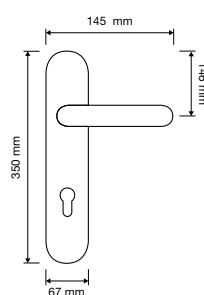

Brilliant Crystal



La musica dell'Opéra di Parigi riaffiora alla mente evocata dalle linee sfarzose di questa maniglia in stile Luigi XIV.

The music of the Paris Opéra comes to mind evoked by the lavish lines of this handle in the Louis XIV style.

made in Italy | patented design



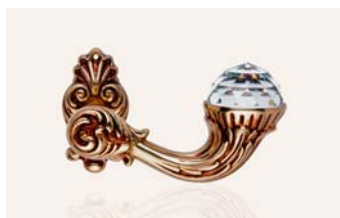

oro francese
french gold
OF



oro zecchino
gold plated
OZ

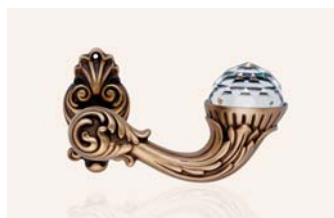

patiné
patiné mat
PM

modelli / models



1526 RB 015

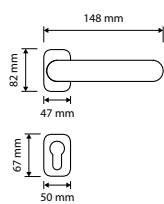

1526 RB 113

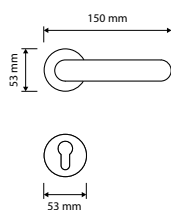

1531 PL

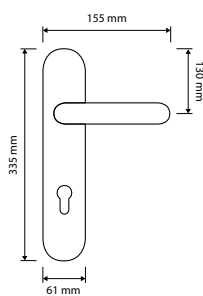

1526 PL

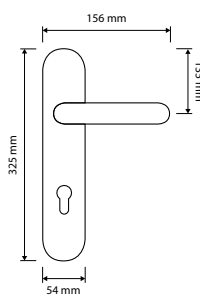

1530 PL

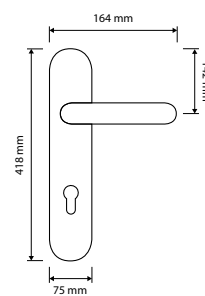

Brilliant Diamond



Il mito della cornucopia torna a rivivere con questa rilettura contemporanea dei designer Linea Calì che, grazie a un enorme cristallo Swarovski®, rappresenta uno degli emblemi della ricchezza contemporanea.

The myth of the cornucopia comes back to life thanks to the stylistic reinterpretation of Linea Calì which, thanks to an imposing Swarovski® crystal set in the handgrip, represents one of the emblems of contemporary wealth.

made in Italy | patented design





oro francese
french gold
OF



oro zecchino
gold plated
OZ

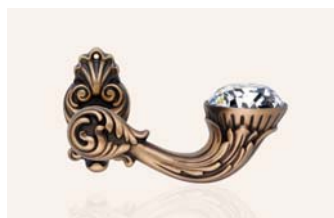

patiné
patiné mat
PM

modelli / models



1525 RB 015

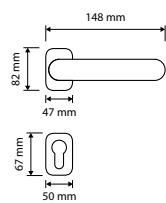

1525 RB 113

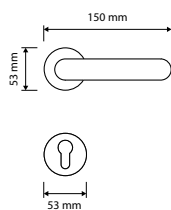

1528 PL

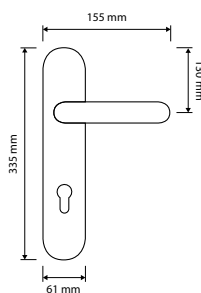

1527 PL

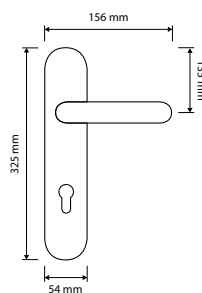

1529 PL

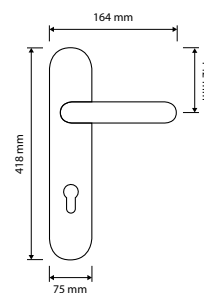

Charme

L'estro dello stile barocco rivive grazie al sontuoso ornato di questa preziosa collezione che unisce la grande maestria della lavorazione artigianale italiana al design più autentico.

The flair of the Baroque style lives once more thanks to the sumptuous ornamentation of this precious collection that combines the great skill of Italian craftsmanship with the most authentic design.

made in Italy | patented design





nero francese
french black
NF



oro francese
french gold
OF



oro zecchino
gold plated
OZ



patiné
patiné mat
PM



1590 RB 008

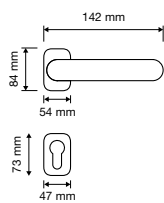

1590 RB 113

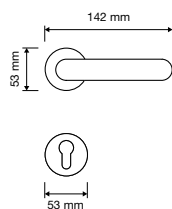

1590 PL

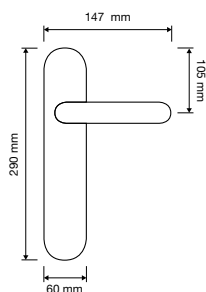

Daisy

Gli scenari per i Balletti Russi di Diaghilev riaffiorano alla mente in questa delicata rappresentazione dello stile Art Déco più autentico.

Scenes from the Russian Ballet of Diaghilev come to mind in this delicate representation of the most authentic Art Déco style.

made in Italy | patented design





bronzo opaco
matt bronze
BM



ottone bronzato satinato
bronzed brass + satin brass mix
OB



oro francese
french gold
OF



oro zecchino
gold plated
OZ



patiné
patiné mat
PM



1070 RB 112

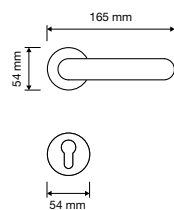

1070 PL

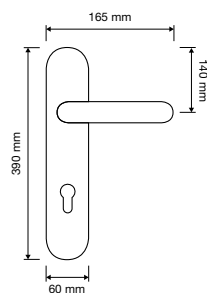

1071 SL

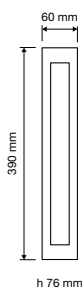

1070 FP

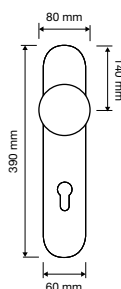

1071 MN 207

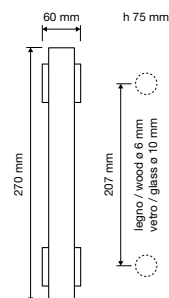

1070 MN 275

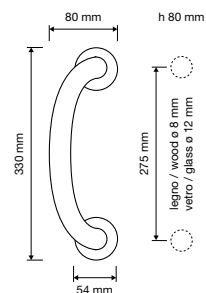



1070 ED/ES

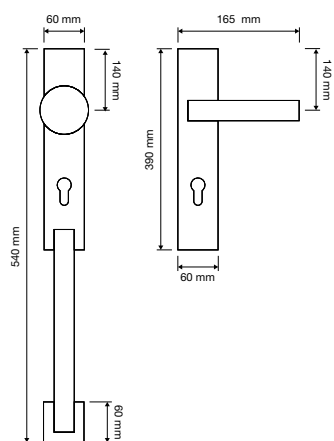

1070 PT

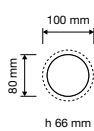

1070 PB 0030

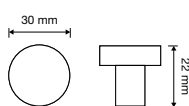

Epoca

Il gusto lezioso e raffinato degli intarsi e gli eleganti rilievi in stile Luigi XVI caratterizzano questa collezione che evoca le magiche atmosfere della reggia di Versailles.

The precious and refined taste of the inlays and the elegant Louis XVI style reliefs characterize this collection that evokes the magic atmosphere of the Palace of Versailles.

made in Italy





oro francese
french gold
OF



oro zecchino
gold plated
OZ



patiné
patiné mat
PM

modelli / models



1210 RB 078

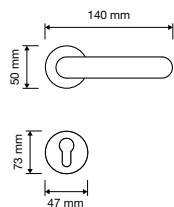

1210 PL

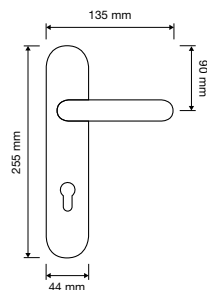

1210 DK

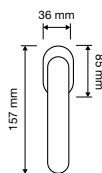

1210 MX

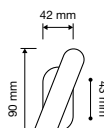

1210 CR

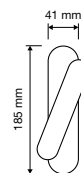

1210 PG

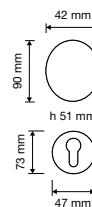

1210 PT

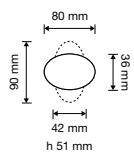

Frida

Esuberante e all'avanguardia, con le sue forme rigorose e i fregi che ricordano i tratti di un gentil pennello di chissà quale artista.

Exuberant and avant-garde with its meticulous forms and friezes that recall the brush strokes of an artist.

made in Italy | patented design





bronzopaco
matt bronze
BM



oro francese
french gold
OF



oro zecchino
gold plated
OZ



patiné
patiné mat
PM

modelli / models



1700 RB 007

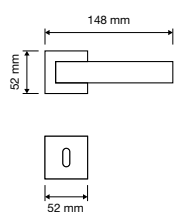

1700 PL

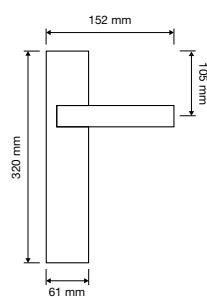

1700 PG 007

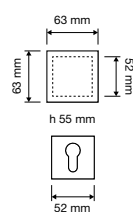

1700 MN 300

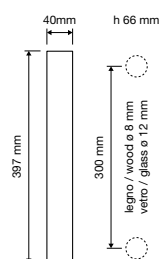

1700 PB 0031

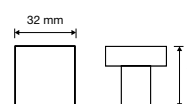

1700 MB 0096

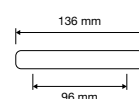

Glamor

L'arte della purificazione delle forme caratterizza questa collezione di maniglie, elegante e sofisticato esempio di design razionalista risalente al XX secolo.

The art of purifying shapes characterizes this collection of handles, an elegant and sophisticated example of the rationalist design dating back to the XX century.

made in Italy | patented design

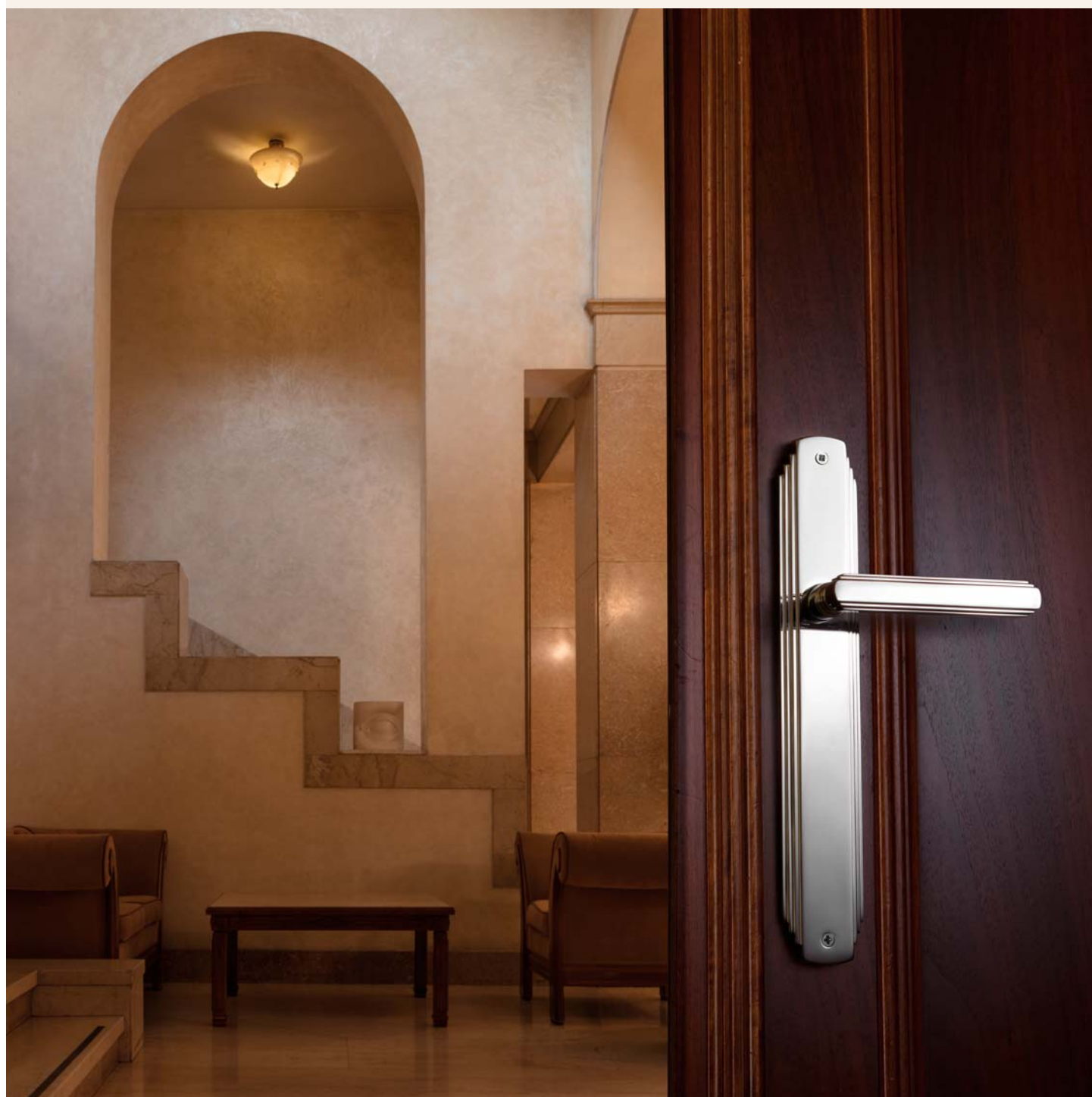



bronzo opaco
matt bronze
BM



cromo lucido
polished chrome
CR



nickel lucido
Polished nickel
NL



ottone lucido verniciato
polished brass
OL



oro zecchino
gold plated
OZ



1555 RB 016

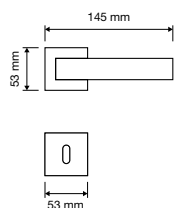

1555 PL

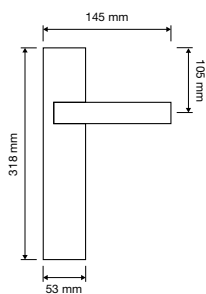

1555 SK

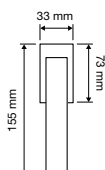

1555 PT

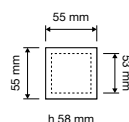

1555 PG

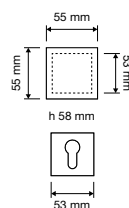

1555 MN 300

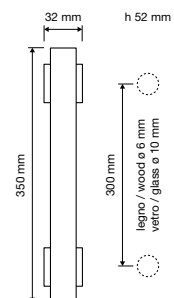

interassi disponibili /
available distances
300 - 400 - 600

Jardin

Un tripudio di finissimi arabeschi floreali caratterizza questa collezione particolarmente elegante di chiara ispirazione Luigi XIV.

A triumph of fine floral arabesques characterizes this particularly elegant collection clearly inspired by Louis XIV.

made in Italy | patented design

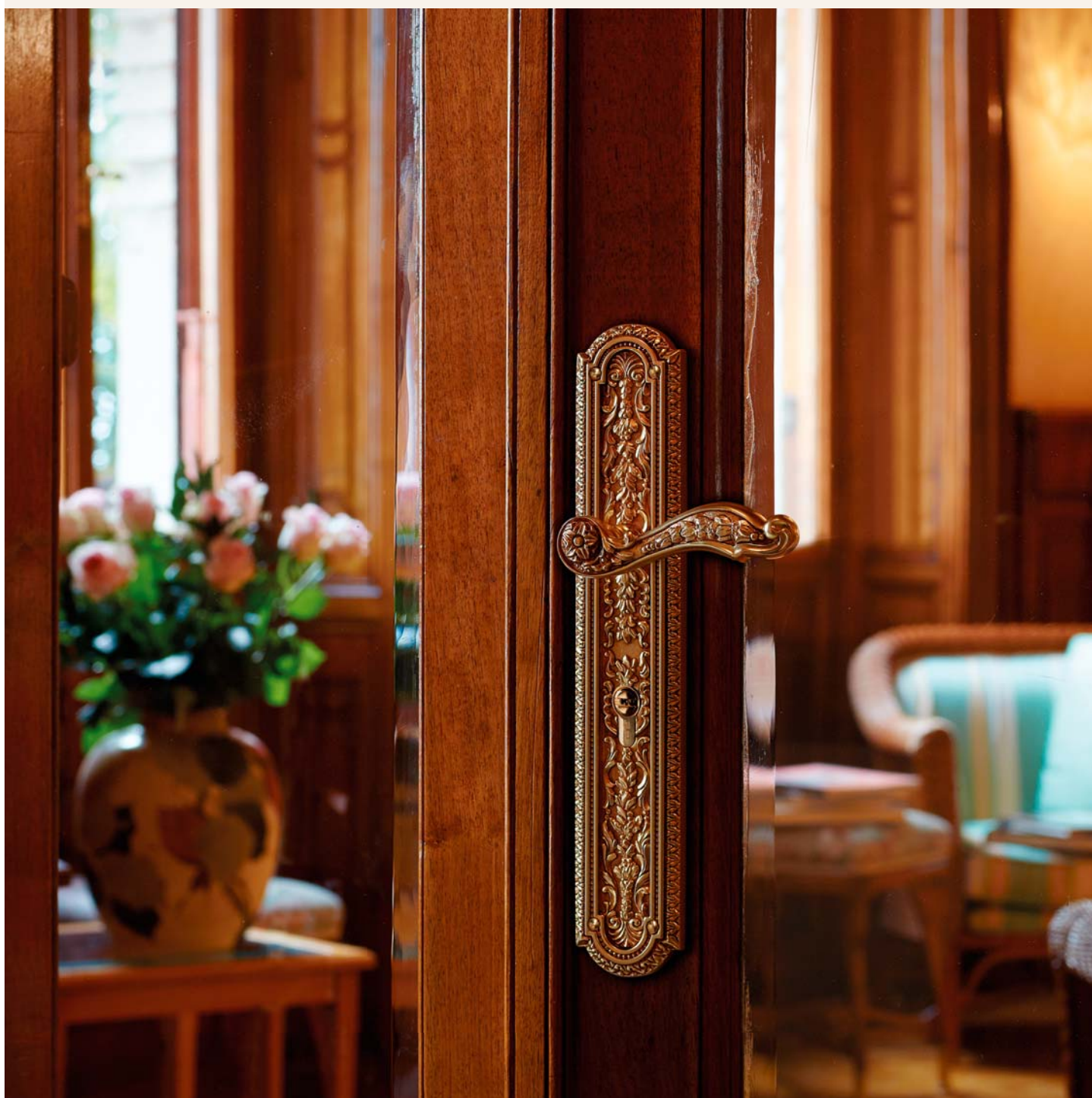



nero francese
french black
NF



oro francese
french gold
OF



oro zecchino
gold plated
OZ



patiné
patiné mat
PM

modelli / models



1560 RB078

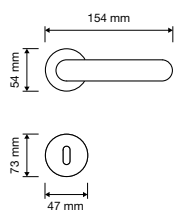

1560 RB115

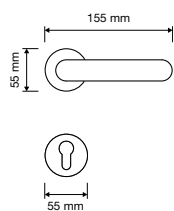

1562 PL

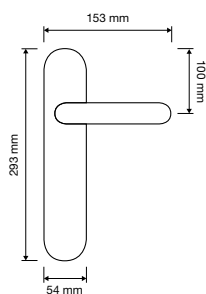

1560 PL

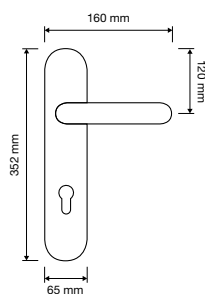

1560 ED-ES

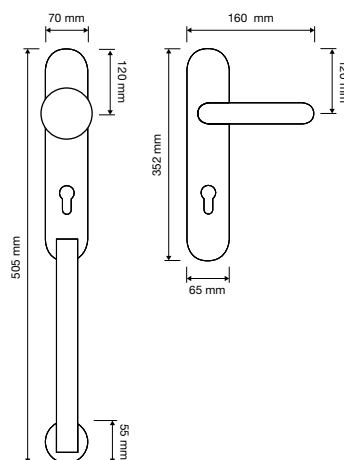



1560 SL

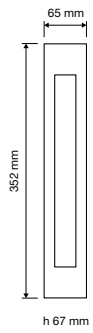

1560 MN 400

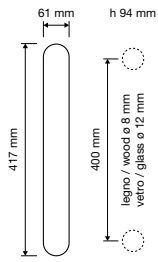

interassi disponibili /
available distances
400 - 500 - 600
700 - 800

Liberty

Semplici figure di evidente ispirazione Liberty sembrano prendere vita ed evolversi naturalmente in forme simili a piante e fiori.

Simple figures clearly inspired by the Liberty style seem to come to life and evolve naturally into forms similar to plants and flowers.

made in Italy | patented design





oro francese
french gold
OF



oro zecchino
gold plated
OZ



patiné
patiné mat
PM



peltro
pewter
TM

modelli / models



1160 RB 091

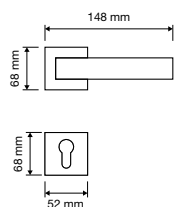

1160 RB 113

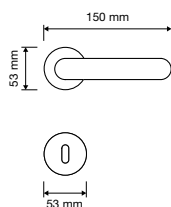

1160 PL

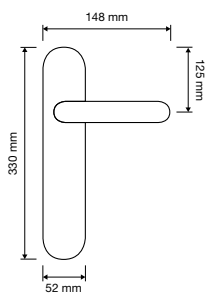

1160 DK

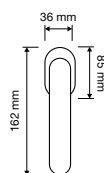

1160 MX

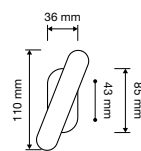

1160 CR

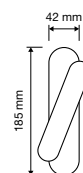

1160 CH

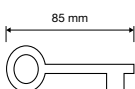



1162 MN 174

1161 MN 234

LIBERTY 1160 MN 380

1162 ED-ES

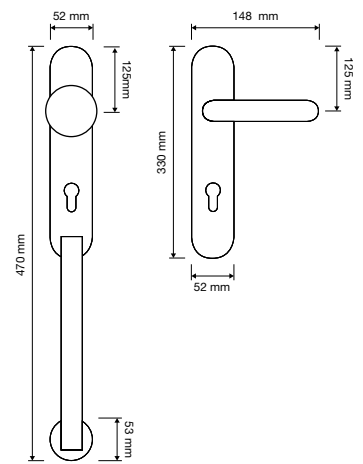
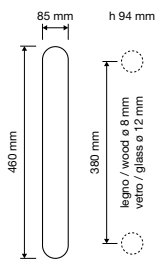
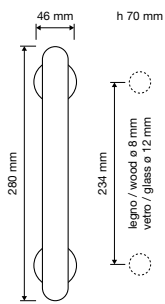
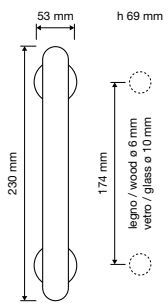

interassi disponibili / available distances
380 - 500 - 700



1160 PT

1160 PG

1160 PI

1160 BA

1160 AB

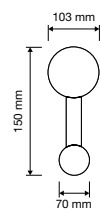
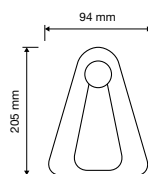
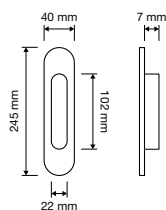
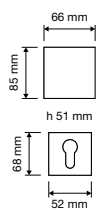
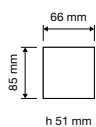

Nature

Lo stile Liberty, privilegio delle più alte classi sociali di un tempo, è qui rappresentato in un trionfo di nervature filiformi di chiara ispirazione vegetale.

The Liberty style, a privilege for the highest social classes of the past, is represented here in a triumph of filiform ribs, clearly inspired by nature.

made in Italy | patented design

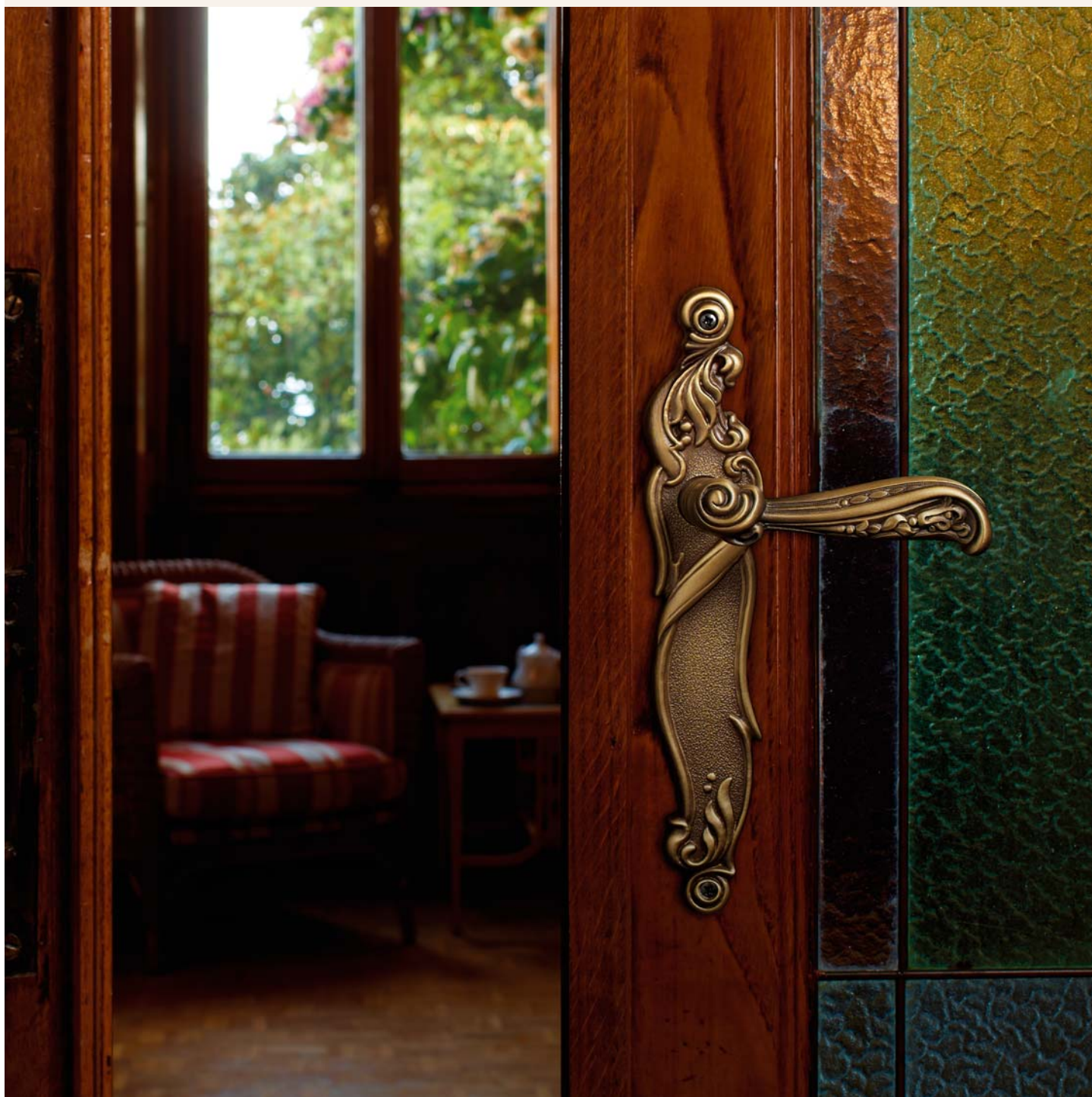



oro francese
french gold
OF



oro zecchino
gold plated
OZ



patiné
patiné mat
PM

modelli / models



1320 RB 018

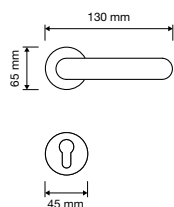

1320 RB 113

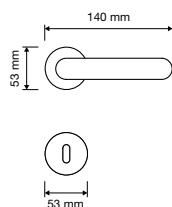

1320 PL

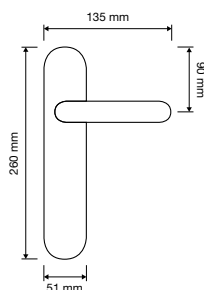

Ninfa

Una collezione classica, facile da abbinare, che arricchisce ogni ambiente con il suo stile vintage particolarmente elegante e sobrio.

A classical collection, easy to match, that elevates every environment with its particularly elegant and sober style.

made in Italy | patented design





oro francese
french gold
OF



oro zecchino
gold plated
OZ



patiné
patiné mat
PM

modelli / models



1540 RB 015

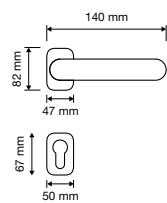

1540 RB 113

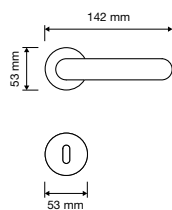

1541 PL

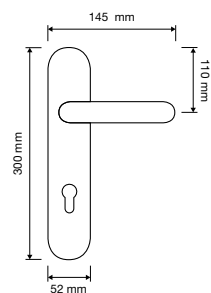

1540 PL

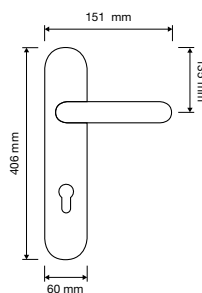

1540 DK

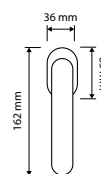

1540 MN 228

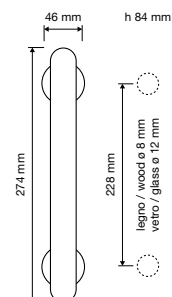

1540 PT

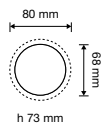

Ninfa Crystal



Un omaggio alla nobiltà di un tempo, una collezione che si distingue per il suo design particolarmente "aristocratico" e raffinato.

A tribute to the nobility of the past, a collection that is distinguished by its particularly "aristocratic" and refined design.

made in Italy | patented design





oro francese
french gold
OF



oro zecchino
gold plated
OZ



patiné
patiné mat
PM

modelli / models



1542 RB 015

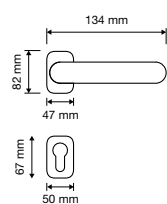

1542 RB 113

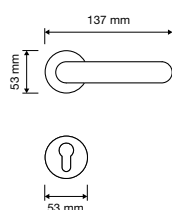

1543 PL

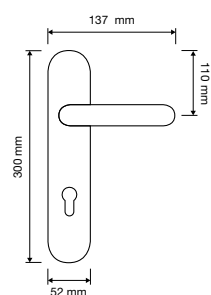

1542 PL

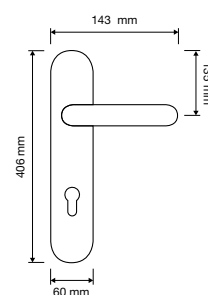

1542 DK

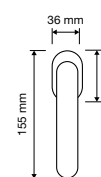

1542 MN 214

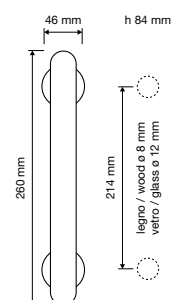

1545 PT

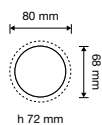

Ninfa Porcellana

L'impugnatura in preziosa porcellana contraddistingue questa collezione che dona un tocco delicatamente vintage agli ambienti contemporanei.

The handgrip in precious porcelain distinguishes this collection, which gives a delicately vintage touch to contemporary environments.

made in Italy | patented design





oro francese
french gold
OF



oro zecchino
gold plated
OZ



patiné
patiné mat
PM

modelli / models



1546 RB 015

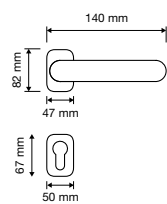

1546 RB 113

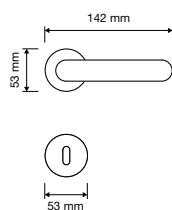

1547 PL

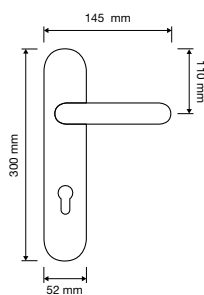

1546 PL

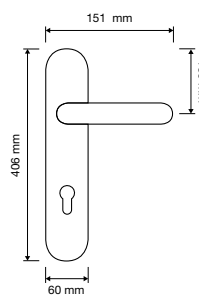

1546 DK

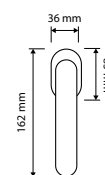

1546 MN 228

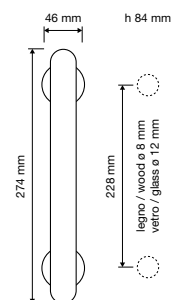

Opera

Le forme severe del Neoclassicismo infondono uno stile rigoroso a questa collezione, caratterizzata da linee orizzontali e verticali che sottolineano l'imponenza del design.

The severe forms of Neoclassicism instil a meticulous style in this collection, characterised by horizontal and vertical lines that highlight the grandeur of the design.

made in Italy





bronzo opaco
matt bronze
BM



ottone bronzato satinato
bronzed brass + satin brass mix
OB



oro francese
french gold
OF



oro zecchino
gold plated
OZ



patiné
patiné mat
PM



1055 RB 112

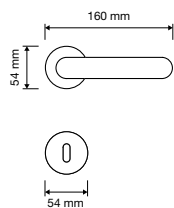

1055 RB 114

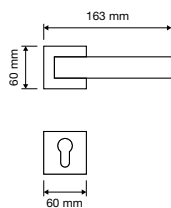

1055 PL

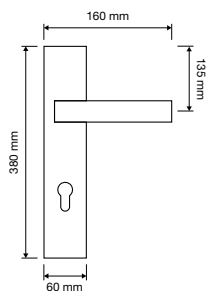

1055 PT

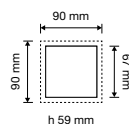

1055 MN 240

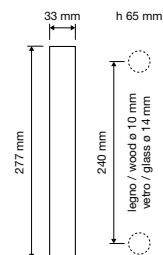

1055 AP 240

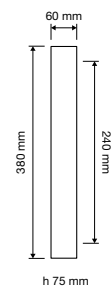



1055 FP

1055 ED-ES

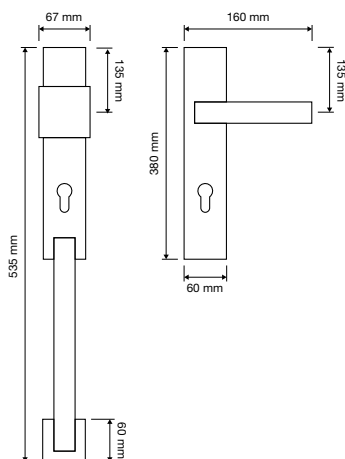
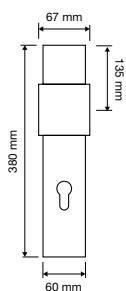

Opera Crystal



L'irresistibile fascino dei cristalli Swarovski® accende questa imponente collezione, caratterizzata da uno stile rigoroso e aristocratico.

The irresistible fascination of Swarovski® crystals lights up this majestic collection, characterised by a meticulous and aristocratic style.

made in Italy

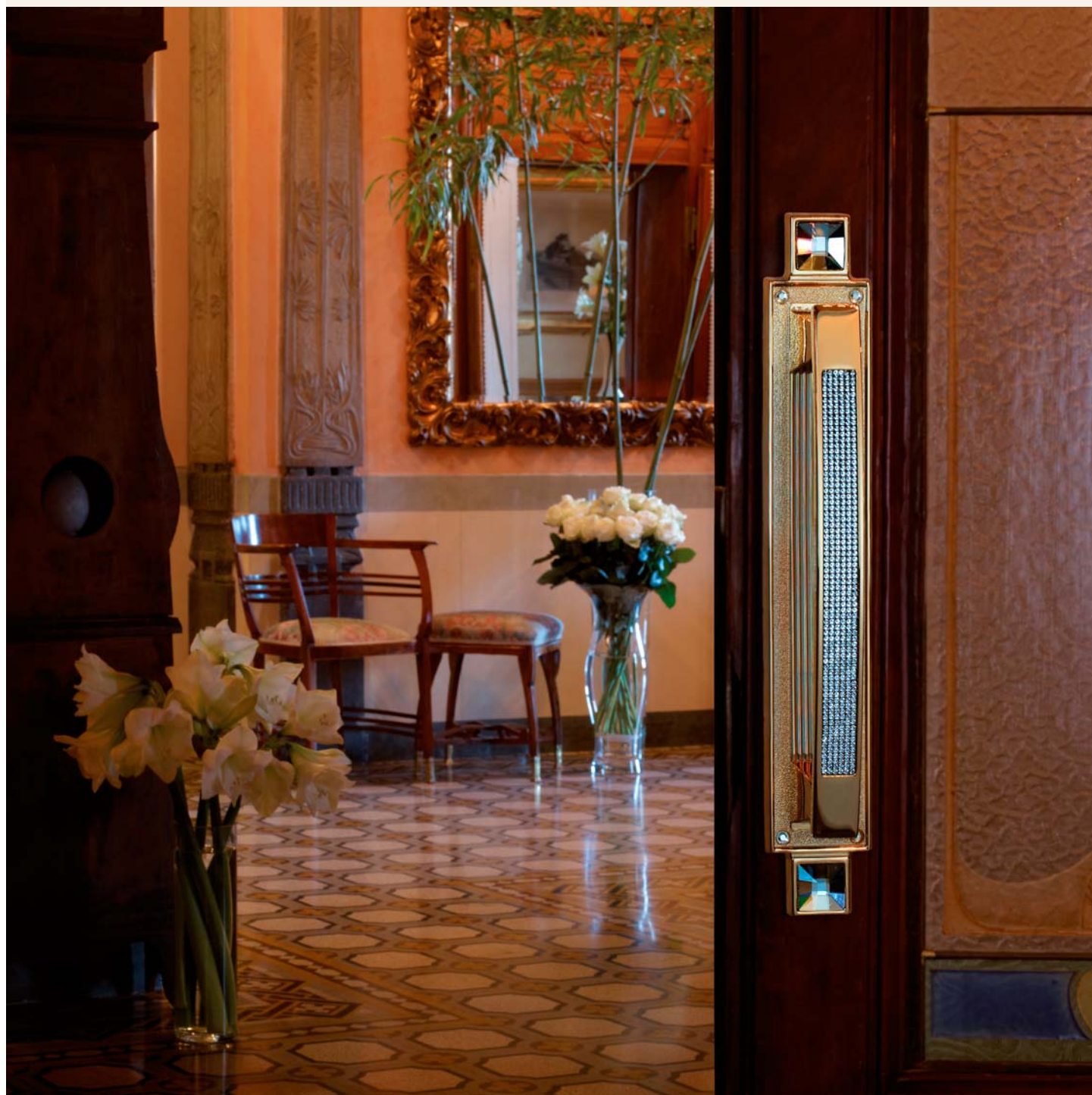



oro zecchino
gold plated
OZ

modelli / models



1056 RB 112

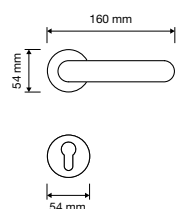

1056 PL

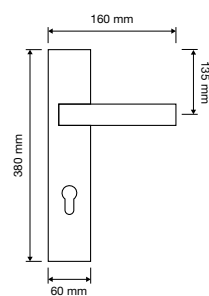

1056 PT

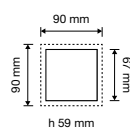

1056 FP

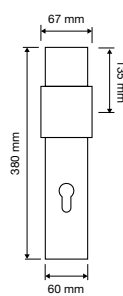

1056 AP 240

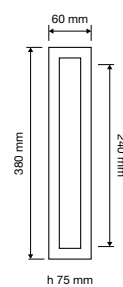

Poesia

Un omaggio allo stile Liberty più autentico, caratterizzato da motivi ispirati alla natura che avvolgono completamente ogni forma rendendola "viva".

A tribute to the most authentic Liberty style, characterised by themes inspired by nature that completely envelop every form making them come "alive".

made in Italy | patented design





argento francese
french silver
AF



oro francese
french gold
OF

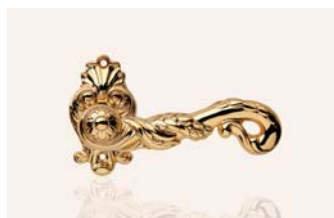

oro zecchino
gold plated
OZ



patiné
patiné mat
PM



1395 RB 015

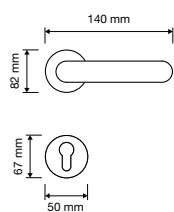

1395 RB 113

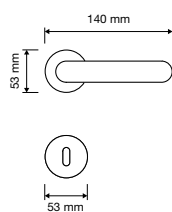

1397 PL

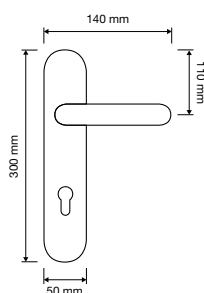

1395 PL

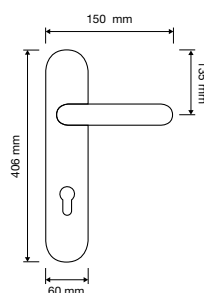

1395 DK

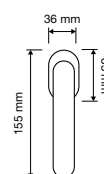

Queen

Esuberanti rilievi ornamentali, sfoggio della tradizione ebanistica francese, fanno rivivere l'indiscutibile fascino dello stile barocco più autentico.

Exuberant ornamental reliefs, a display of traditional French cabinet making, revive the unquestionable charm of the authentic Baroque style.

made in Italy | patented design



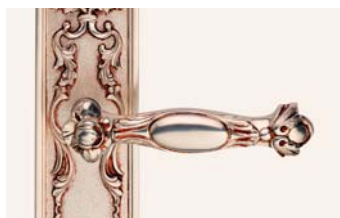

argento francese
french silver
AF



oro francese
french gold
OF



oro zecchino
gold plated
OZ



patiné
ptiné mat
PM

modelli / models



1406 RB 015

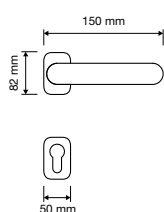

1406 RB 113

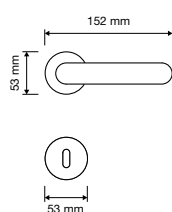

1406 PL

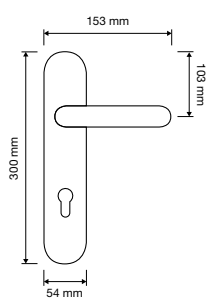

1405 PL

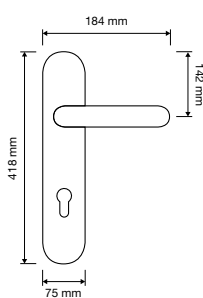

1406 DK

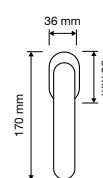

1405 FP

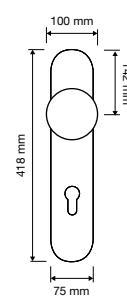



1405 PT

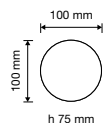

1405 MN 315

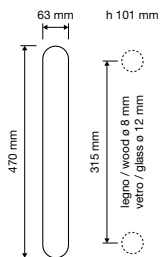

1407 MN 738

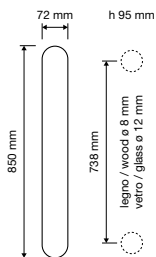

1408 MN 723

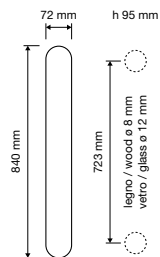

Rococò

La rappresentazione del gusto francese per l'arte, evoluzione dello stile tardo-barocco e tipica rappresentazione della vita aristocratica di allora.

The representation of the French taste in art, evolution of the late-Baroque style and typical representation of the aristocratic life of bygone days.

made in Italy | patented design

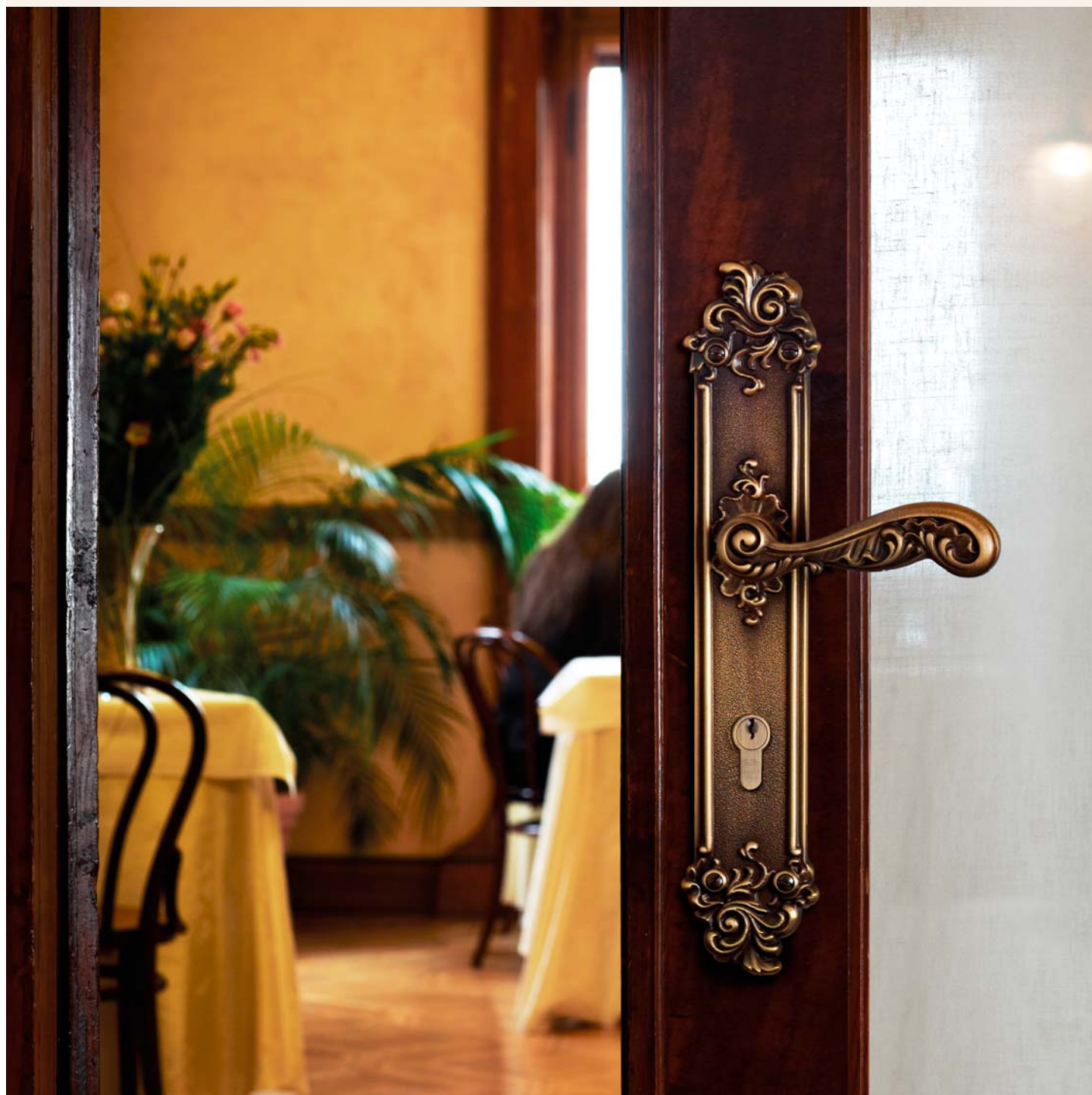



oro francese
french gold
OF



oro zecchino
gold plated
OZ



patiné
ptiné mat
PM

modelli / models



1285 RB 078

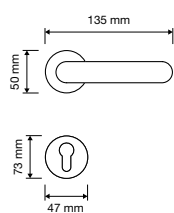

1285 PL

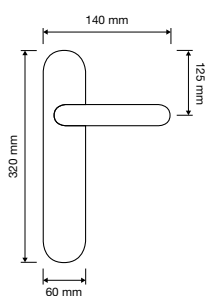

1285 PT

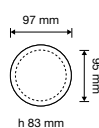

1285 MN 400

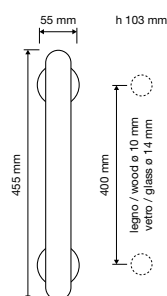

interassi disponibili / available distances
400 - 500 - 600

Sissi

L'ossessione per il culto della bellezza reinventa il classico e dà forma a una collezione elegante e immortale nella sua semplicità.

An obsession with the cult of beauty reinvents the classics and gives shape to a collection that is elegant and immortal in its simplicity.

made in Italy | patented design

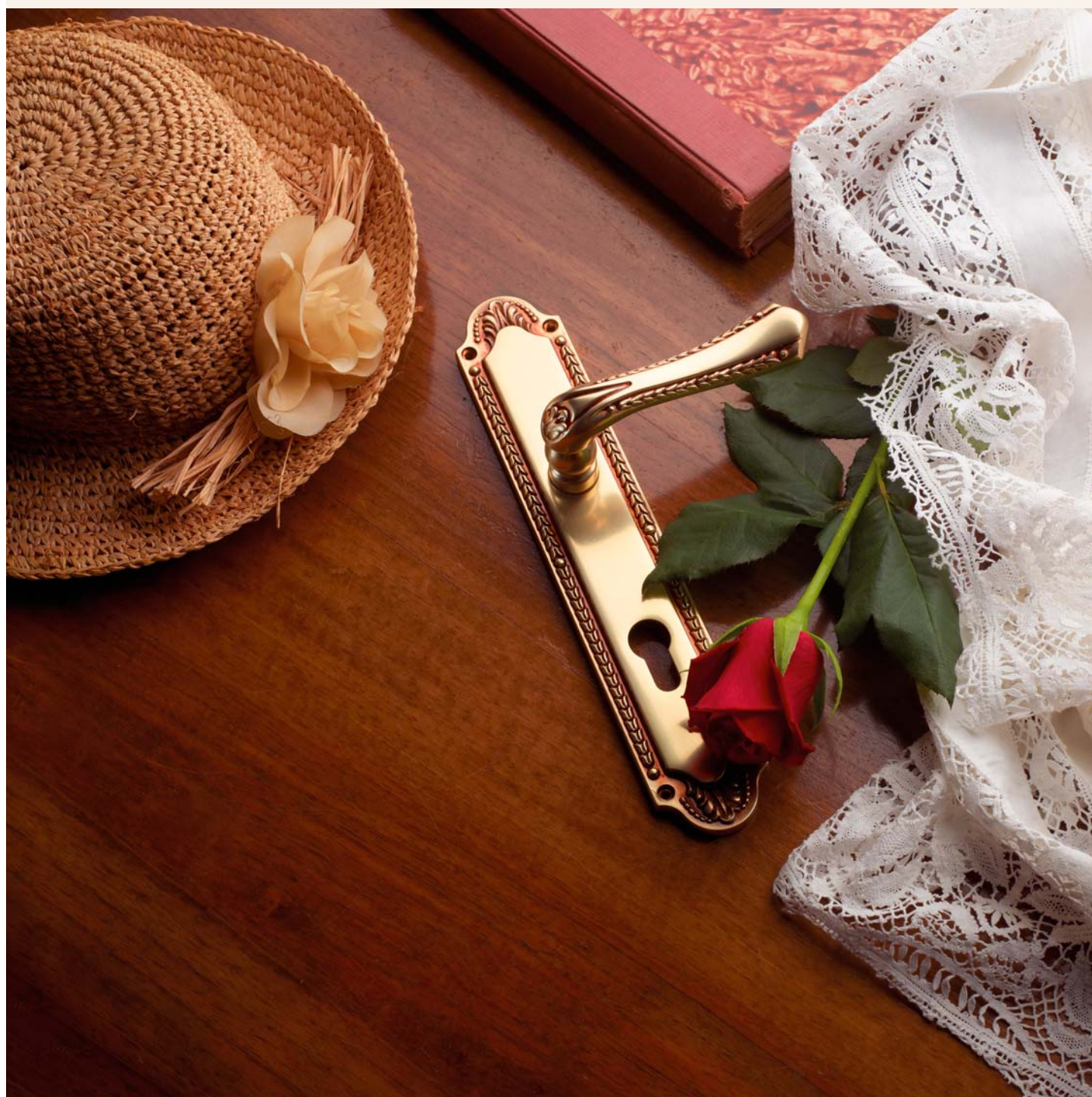



argento antico opaco
antique silver
AA



oro francese
french gold
OF



ottone opaco
matt brass
OO



oro zecchino
gold plated
OZ



patiné
patiné mat
PM



1400 RB 009

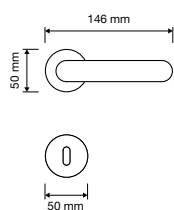

1400 RB 010

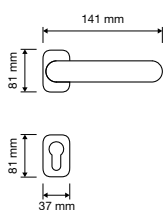

1400 PL

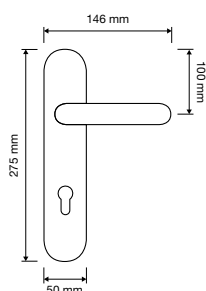

1400 PG 010

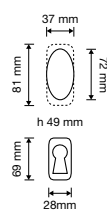

1400 PT 010

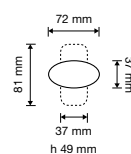

1400 CR 1400 PP

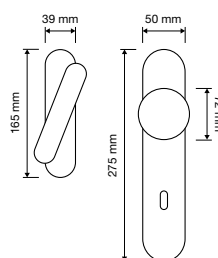

Soleil

La sontuosità e i fasti del Re Sole vengono evocati da raffinatissimi rilievi ornamentali in stile Luigi XIV, ottenuti grazie alla tecnica dell'intarsio del quale ne era maestro l'ebanista francese André-Charles Boulle.

The wealth and magnificence of the Sun King are evoked by refined ornamental embossments in the Louis XIV style, obtained thanks to the inlay technique of which the French cabinet-maker André-Charles Boulle was a master.

made in Italy | patented design

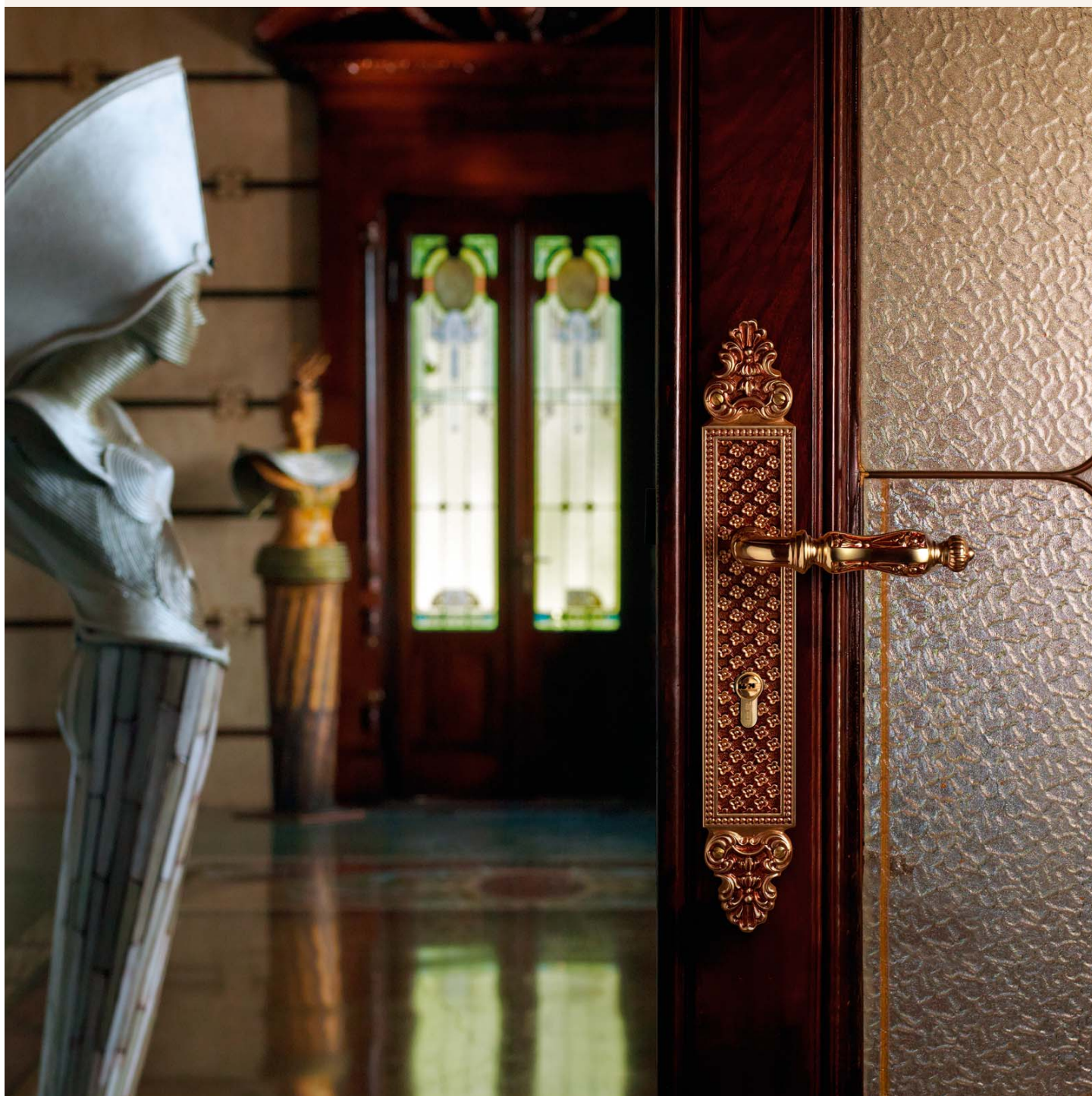



argento antico opaco
antique silver
AA

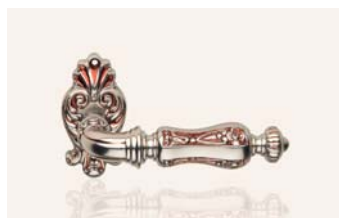

argento francese
french silver
AF



oro francese
french gold
OF



oro zecchino
gold plated
OZ



patiné
patiné mat
PM



1325 RB 015

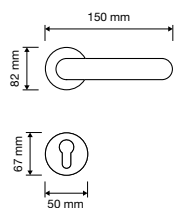

1325 RB 113

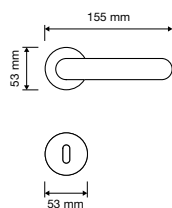

1325 PL

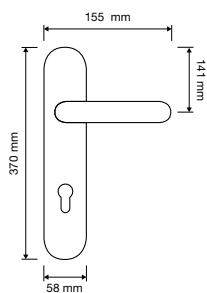

1325 DK

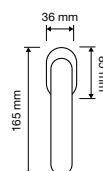

Tiffany

Uno stile Tiffany austero, ma non per questo meno dolce e piacevole, caratterizzato da particolari finiture che imprimono alla collezione uno stile autentico.

An austere Tiffany style, but no less sweet and pleasant, characterised by particular finishes that give the collection an authentic style.

made in Italy | patented design

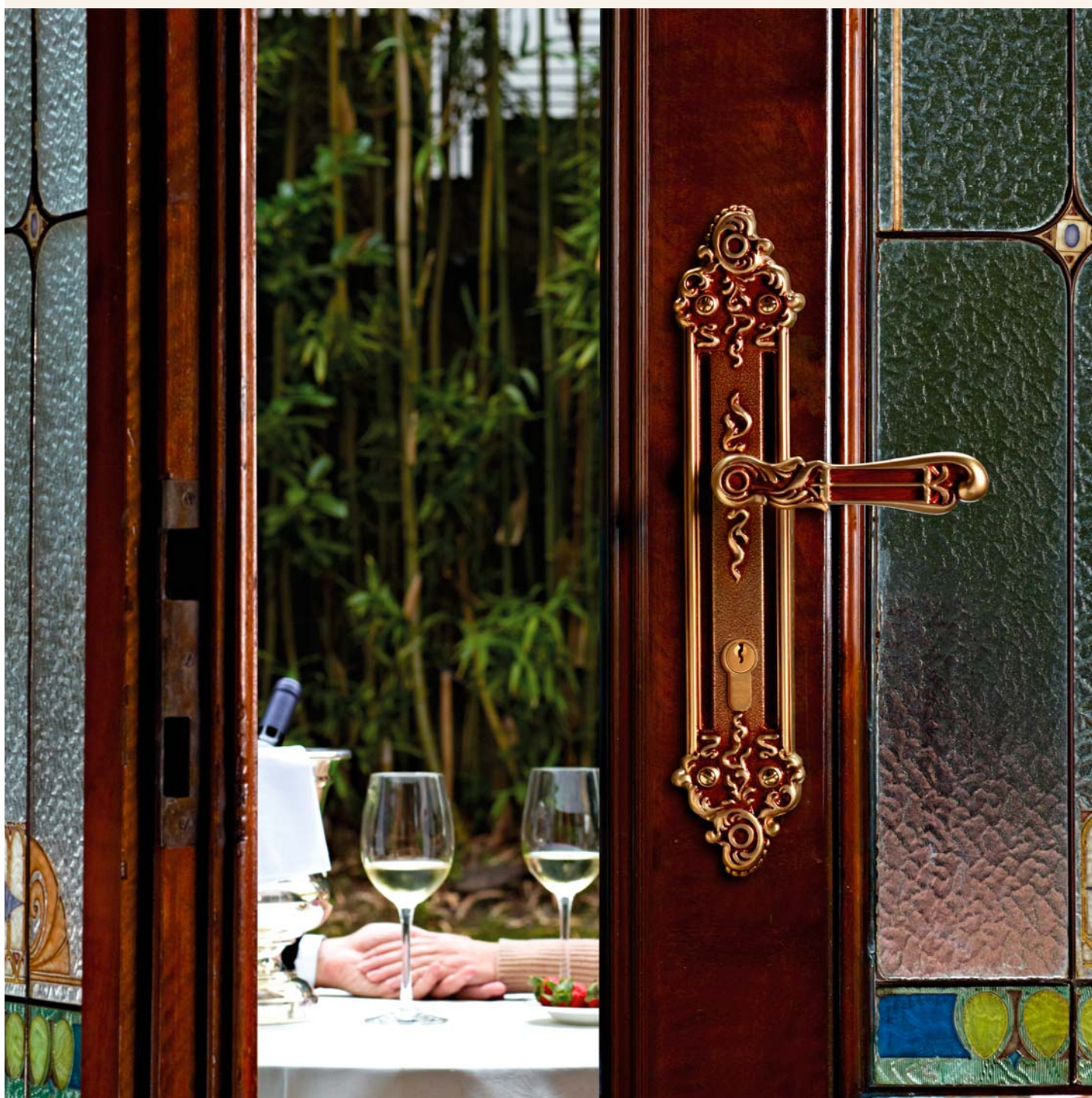



oro francese
french gold
OF



oro zecchino
gold plated
OZ



patiné
patiné mat
PM



peltro
pewter
TM



1308 RB 018

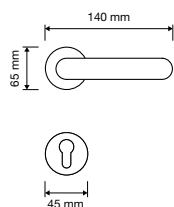

1308 RB 113

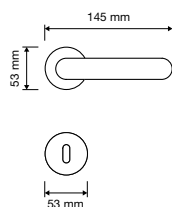

1308 PL

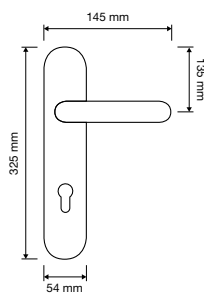

1308 PT

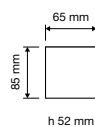

1308 MN 232

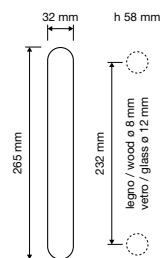

Tiffany Mesh



Pavè di cristalli Swarovski® accendono le forme con estrema raffinatezza dando vita a una rilettura contemporanea dello stile Tiffany più autentico.

A pavè of Swarovski® crystals illuminates the forms with extreme sophistication giving life to a contemporary reinterpretation of the most authentic Tiffany style.

made in Italy | patented design

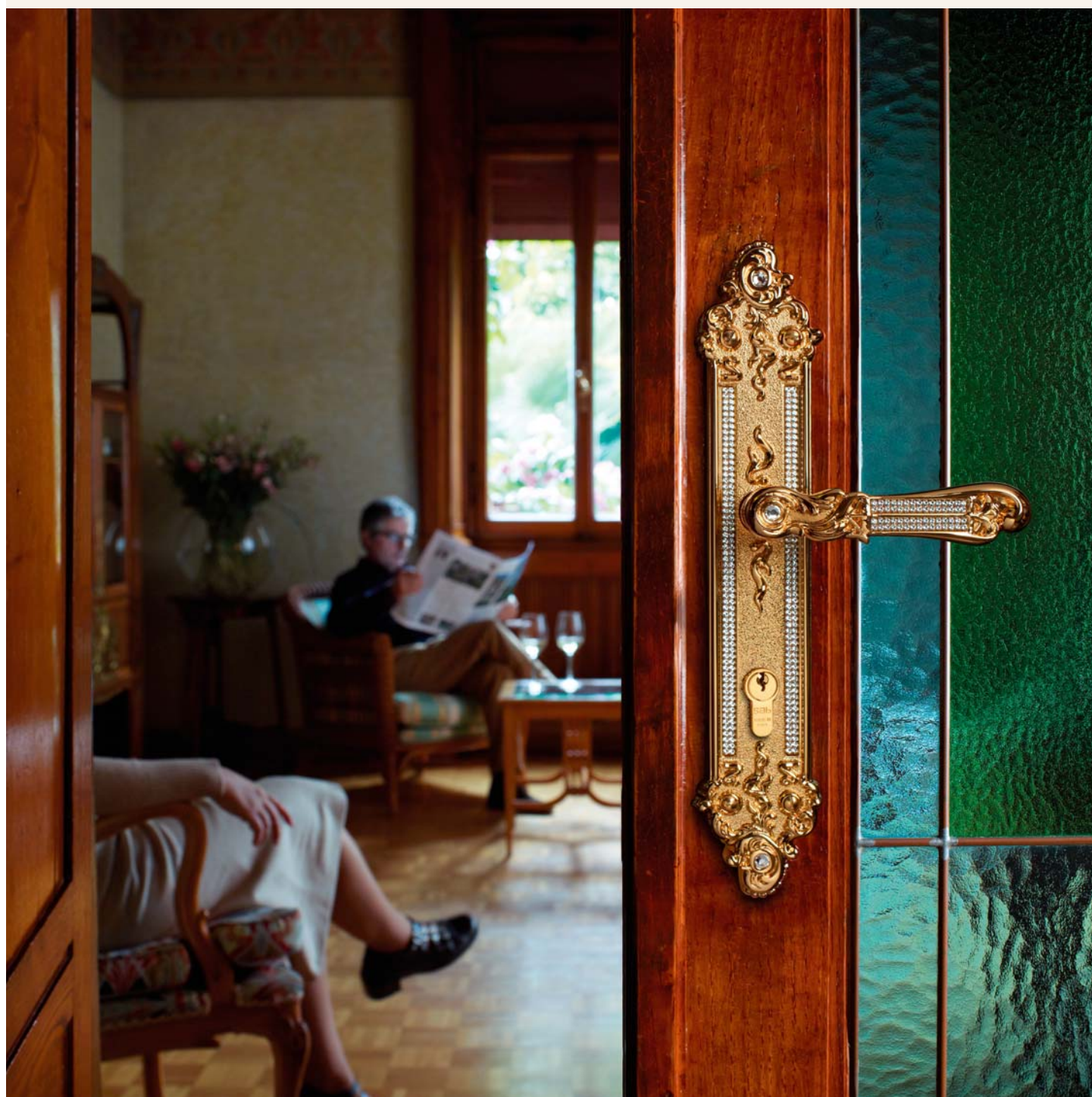



oro francese
french gold
OF



oro zecchino
gold plated
OZ



patiné
patiné mat
PM



peltro
pewter
TM



1307 RB 018

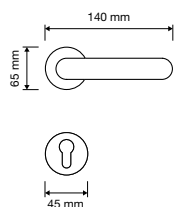

1307 RB 113

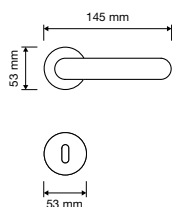

1307 PL

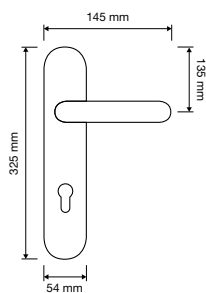

1307 PT

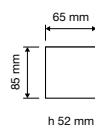

1307 MN 232

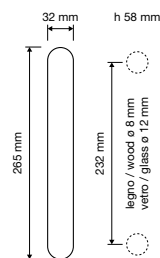

Tiffany Vetro

Autentici inserti in vetro realizzati artigianalmente caratterizzano questa collezione dall'inconfondibile stile di Louis Comfort Tiffany, co-fondatore della gioielleria Tiffany & Co.

Authentic hand-made inserts in glass characterise this collection with an unmistakable style of Louis Comfort Tiffany, co-founder of the jeweller Tiffany & Co.

made in Italy | patented design

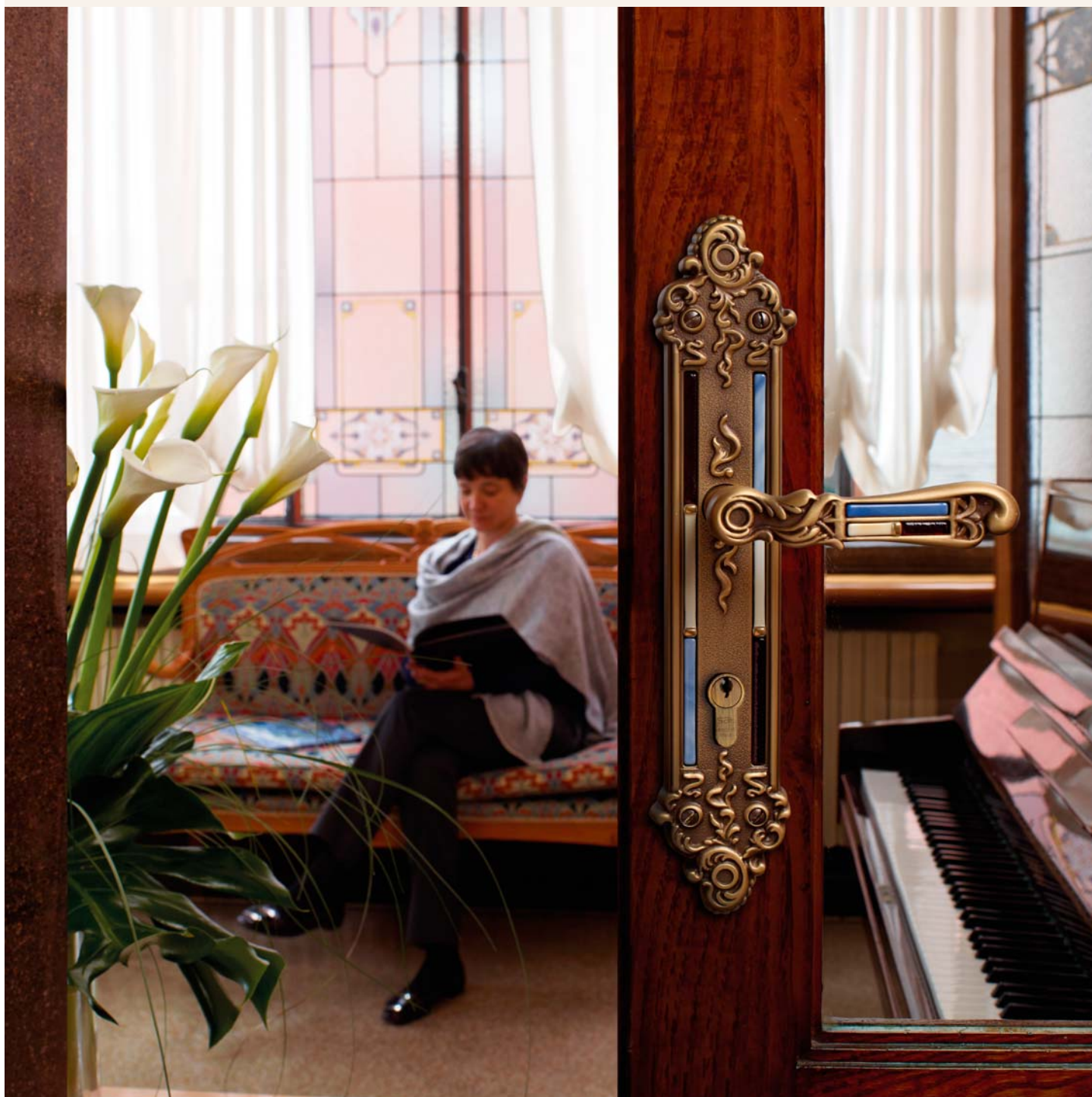



oro francese
french gold
OF



oro zecchino
gold plated
OZ



patiné
patiné mat
PM



peltro
pewter
TM

fantasia | fantasy



vetro fantasia blu
blue fantasy glass
BB 1306



vetro fantasia marrone
brown fantasy glass
MG 1305

modelli / models



1306 RB 018

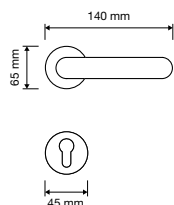

1306 RB 113

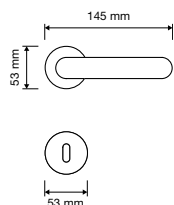

1306 PL

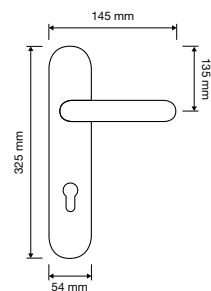

1306 MX

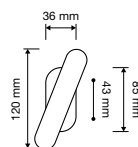

1306 PT

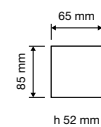

1306 MN 232

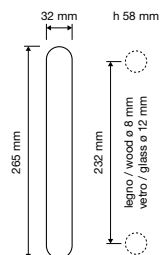

Zaara

Il fascino orientale del Taj Mahal è rievocato in questa imponente collezione, omaggio al più grande monumento al mondo fatto erigere per amore.

The oriental fascination of the Taj Mahal is evoked in this impressive collection, a tribute to the greatest monument in the world erected to love.

made in Italy | patented design

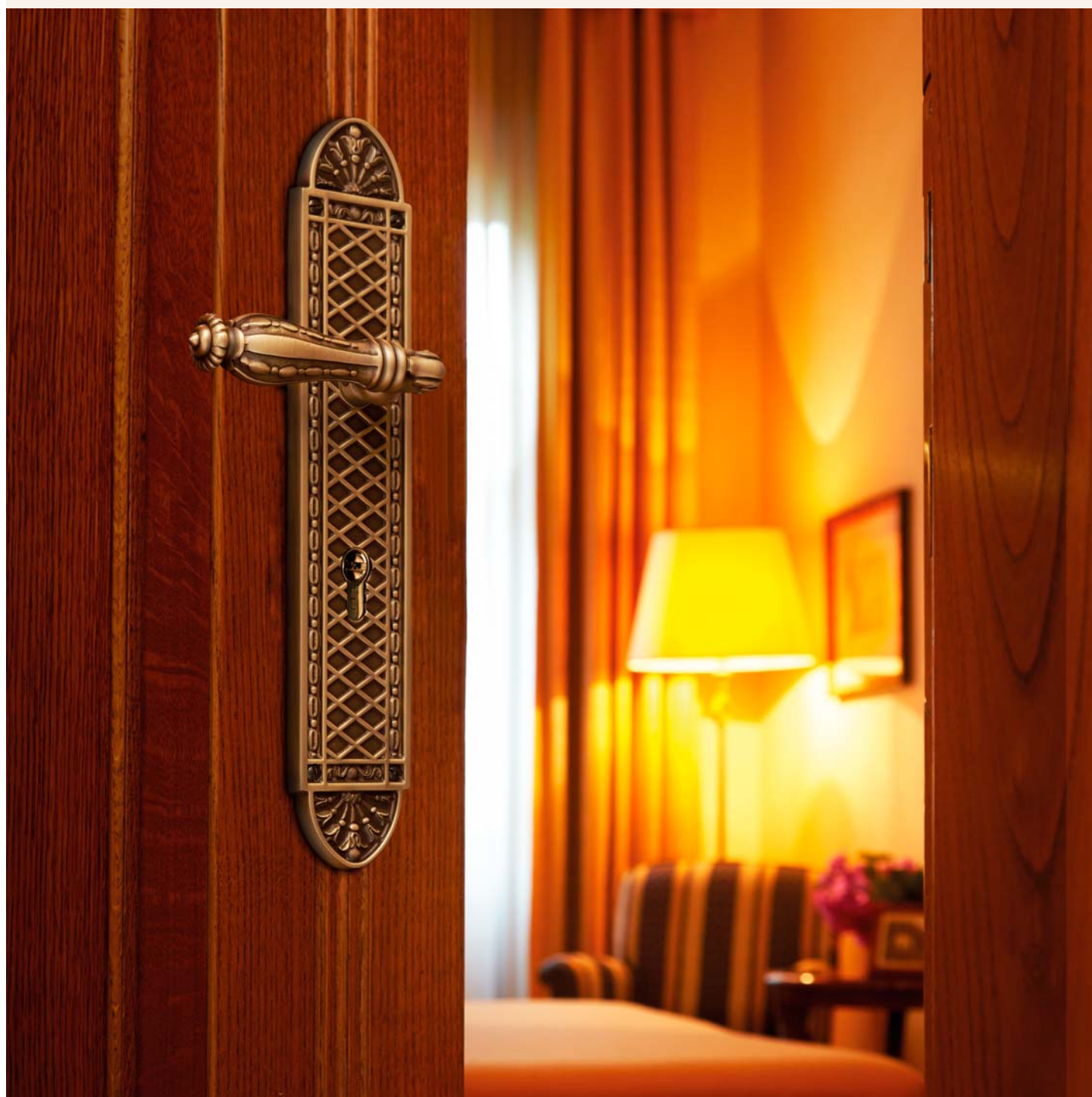



argento francese
french silver
AF

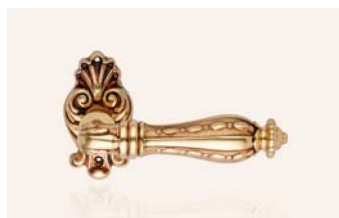

oro francese
french gold
OF



oro zecchino
gold plated
OZ

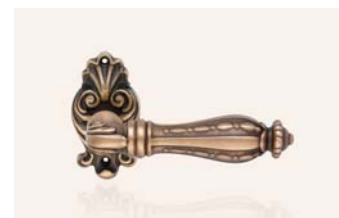

patiné
patiné mat
PM



1535 RB 015

1535 RB 113

1563 PL

1535 PL

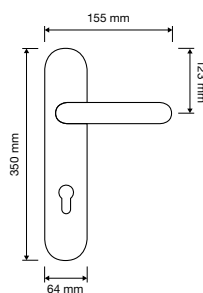
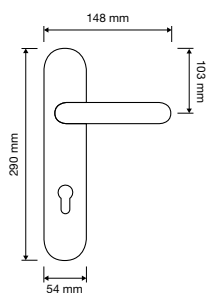
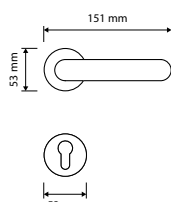
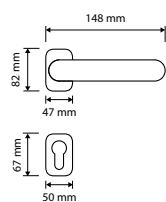

crystal handles with
Swarovski® crystals



crystal

Cosmic



Il concetto di maniglia classica viene riletto in chiave moderna e arricchito da dettagli contemporanei come il ricciolo dell'impugnatura e il cristallo Swarovski® di forma squisitamente circolare.

The conventional handle is given a modern twist and enhanced with contemporary details such as the curl of the hand grip and the Swarovski® crystal with the delightfully rounded shape.

made in Italy | patented design





Cromo lucido
polished chrome
CR



Cromo satinato
satin chrome
CS



Oro zecchino
gold plated
OZ

fantasia | fantasy



Swarovski® cristallo
crystal Swarovski®
1335

modelli / models



1335 RB 103

1335 PL



1335 SK 



209 PB mm 22



209 PB mm 30

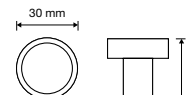
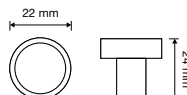
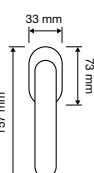
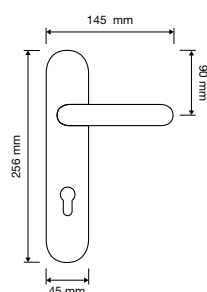
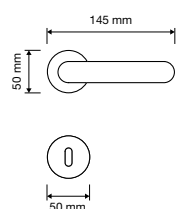

Crystal



La bellezza dei cristalli Swarovski® è oggetto di culto in questa collezione dalle linee importanti ma allo stesso tempo eleganti.

The beauty of Swarovski® crystals is an object of worship in this collection that is made up of formal but at the same time elegant lines.

made in Italy





Cromo lucido
polished chrome
CR



Oro zecchino
gold plated
OZ

modelli / models



830 RB 103

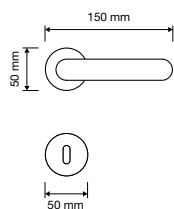

830 SK

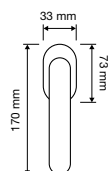

830 CR

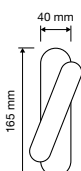

830 MN 236

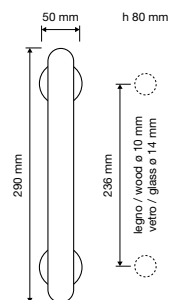

830 PT

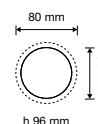

830 PG 103

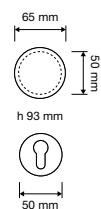

interassi disponibili /
available distances
236 - 310 - 420 - 500



200 PB 0020

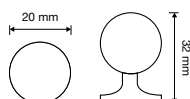

200 PB 0030

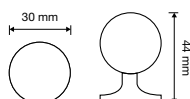

200 PB 0040

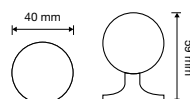

Diamante



Un grande classico del Made in Italy dall'eleganza discreta acquisisce una seconda giovinezza grazie alla preziosa impugnatura realizzata interamente in cristallo Swarovski®.

A great classic, clearly Made in Italy, with a discreet elegance, acquires a second youth thanks to the precious hand grip made entirely of Swarovski® crystal.

made in Italy





Cromo lucido
polished chrome
CR

Oro zecchino
gold plated
OZ

modelli / models



905 RB 103

905 PL

905 SK 

905 CR

905 MN 210

905 AB

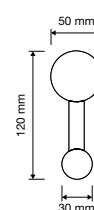
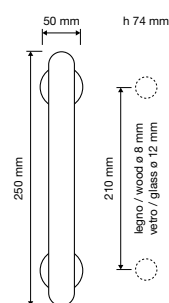
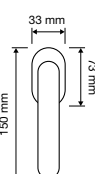
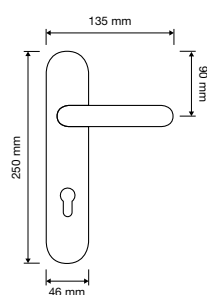
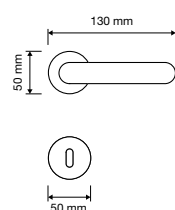

Elika Crystal



Linee sfuggenti donano un'inaspettata dinamicità alle importanti forme, rese ancor più sorprendenti dalla luce emanata da un cristallo Swarovski®.

Elusive lines give an unexpected dynamic to the formal shapes, made even more surprising by the light released by the Swarovski® crystal.

made in Italy





oro zecchino
gold plated
OZ

modelli / models



991 RB 108

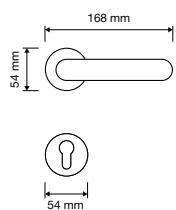

991 PL

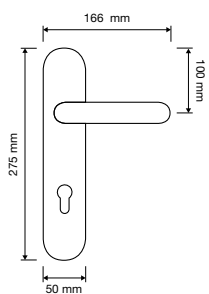

991 SK

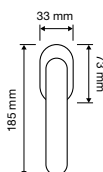

991 CR

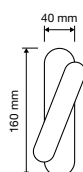

991 MN 275

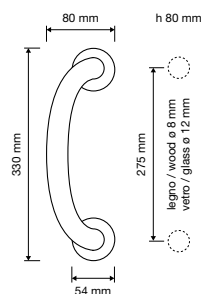

991 BA

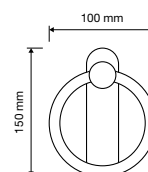

991 PT

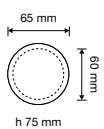

991 PG 108

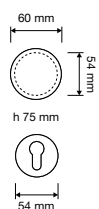

Elios Crystal



Il concetto di modernità è riassunto in questa maniglia dalle forme decise ma aggraziate, impreziosite da un cristallo Swarovski® che sprigiona riflessi dai mille colori.

This handle is the emblem of modern design with decisive yet graceful shapes, embellished with a Swarovski® crystal that emanates multi coloured reflections.

made in Italy | patented design





Cromo lucido
 polished chrome
 CR



Cromo satinato
 satin chrome
 CS



Oro zecchino
 gold plated
 OZ

fantasie / fantasy



Swarovski® cristallo
 crystal Swarovski®
 1340



Swarovski® jet nero
 black jet Swarovski®
 1343



Swarovski® mesh cristallo
 mesh crystal Swarovski®
 1344

modelli / models



1340 RB 019

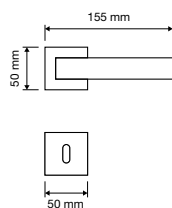

1340 RB 024

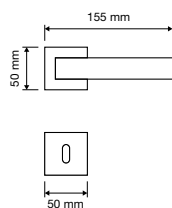

1340 PL

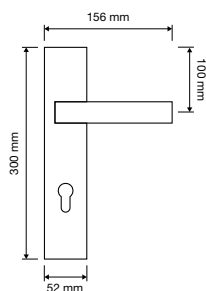

1340 SK

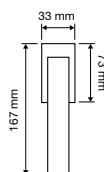

Fish Crystal



Una forma semplice ma molto simbolica che evoca la calma, l'armonia e una sorta di mistero, peculiarità dell'ambiente marino.

A simple but very symbolic form that evokes tranquillity, harmony and a sort of mystery, a distinctive feature of marine environments.

made in Italy | patented design





Cromo lucido
polished chrome
CR



Cromo satinato
satin chrome
CS



Oro zecchino
gold plated
OZ

modelli / models



700 RB 023

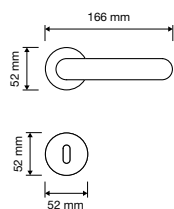

700 RB 025

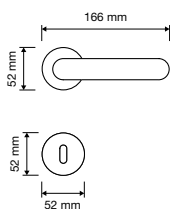

700 PL

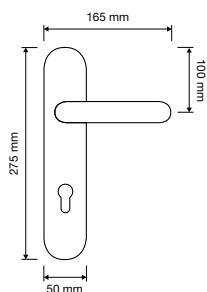

700 SK

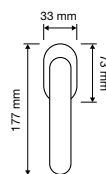

Gemma



Una preziosa gemma in cristallo Swarovski® ridefinisce la preziosa impugnatura di questa eclettica ed elegante maniglia.

A precious gem made of Swarovski® crystal redefines the beautiful handgrip of this eclectic and elegant handle.

made in Italy





cromo lucido
polished chrome
CR



cromo satinato
satin chrome
CS



oro zecchino
gold plated
OZ

fantasie / fantasy



Swarovski® cristallo
crystal Swarovski®
1120



Swarovski® viola
violet Swarovski®
1121

modelli / models

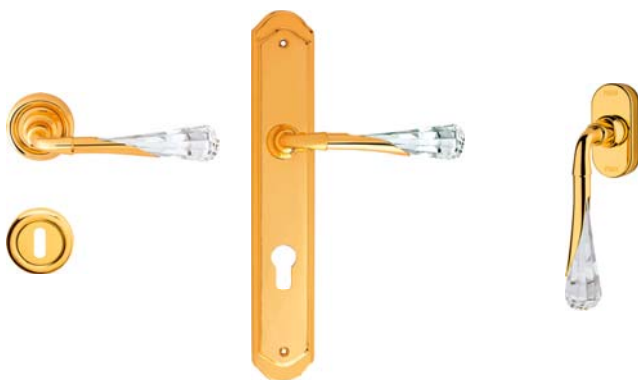

1120 RB 103

1120 PL

1120 SK 

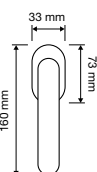
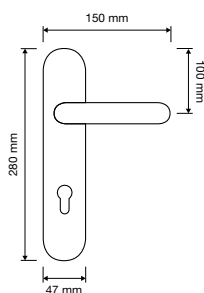
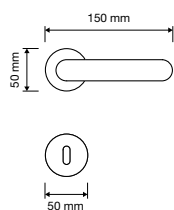

Havana Mesh



Come un gioiello esalta la bellezza di una donna, un anello tempestato di cristalli Swarovski® illumina questa collezione sprigionando infiniti riflessi dai mille colori.

Just as a jewel brings out the beauty in a woman, a ring studded with Swarovski® crystals illuminates this collection bursting with infinite multi colour reflections.

made in Italy





Cromo lucido
polished chrome
CR

Oro zecchino
gold plated
OZ

modelli / models



1090 RB 102

1090 PL

1090 SK 

1090 MN 267

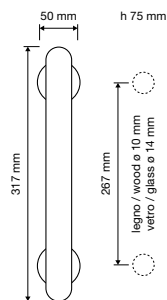
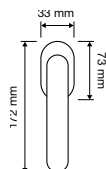
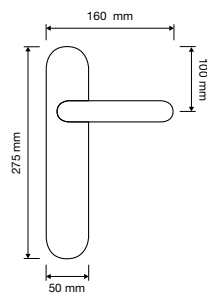
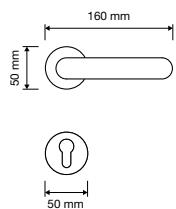

Idea Crystal



Il cristallo Swarovski® incastonato nell'impugnatura pone l'accento sulle linee aggraziate e sinuose che rendono questa collezione "leggera" ma preziosa.

The Swarovski® crystal set in the hand grip highlights the graceful and sinuous lines that make this collection "light" but precious.

made in Italy





oro zecchino
gold plated
OZ

modelli / models



871 RB 103

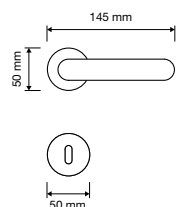

871 PL

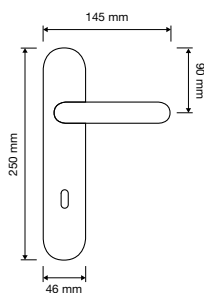

871 SK 

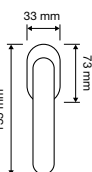

871 CR

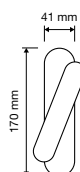

Luce



Le atmosfere del Teatro La Fenice di Venezia e la voce di Maria Callas riaffiorano in questa raffinata collezione, contraddistinta dall'impugnatura in cristallo Swarovski®.

The atmosphere of Teatro La Fenice, the Phoenix Opera House in Venice, and the voice of Maria Callas re-emerges in this refined collection, characterised by the hand grip in Swarovski® crystal.

made in Italy | patented design





Cromo lucido
 polished chrome
 CR



Cromo satinato
 satin chrome
 CS



Oro zecchino
 gold plated
 OZ

fantasie / fantasy



Swarovski® cristal
 crystal Swarovski®
 1445



Swarovski® mesh cristal
 mesh crystal Swarovski®
 1446

modelli / models



1445 RB 023

1445 RB 025

1445 PL

1445 SK

1445 MN 252

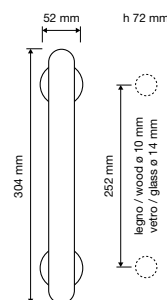
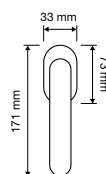
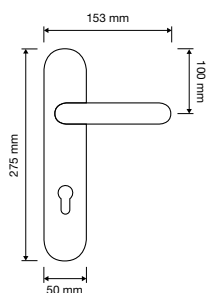
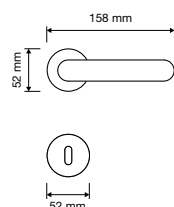
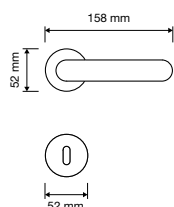

Nau Crystal



Un'insolita forma a spirale ospita una "perla" in cristallo Swarovski® che sprigiona riflessi dai mille colori.

An unusual spiral form holds a "pearl" in Swarovski® crystal that releases multi-coloured reflections.

made in Italy | patented design





Cromo lucido
polished chrome
CR



Cromo satinato
satin chrome
CS



Oro zecchino
gold plated
OZ

modelli / models



1549 RB 023

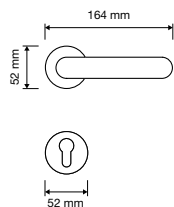

1549 RB 025 ><

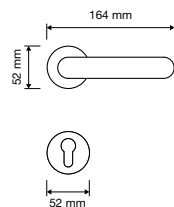

1549 PL

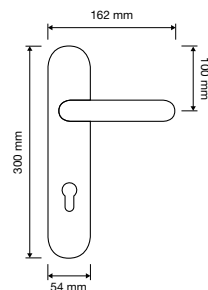

1549 SK

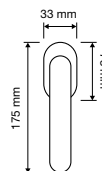

Point Crystal



L'iconografia moderna è il leitmotiv di questa maniglia, priva di qualsiasi angolo vivo, illuminata da un importante cristallo Swarovski®.

Modern iconography is the leitmotiv of this handle, free of sharp edges, illuminated by an important Swarovski® crystal.

made in Italy





Cromo lucido
polished chrome
CR



Cromo satinato
satin chrome
CS



Oro zecchino
gold plated
OZ

modelli / models



1596 RB 023

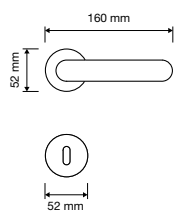

1596 RB 025

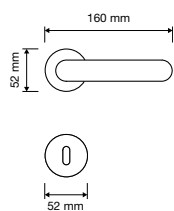

1596 SK

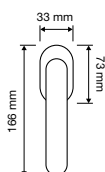

Profilo Mesh



La mano coglie la luce sfiorando un pavé di cristalli Swarovski® che rimanda all'arte orafa più preziosa.

The hand that lightly touches the Swarovski® crystals pavé captures the light and reminds us of the intricate work of the goldsmith.

made in Italy | patented design





Cromo lucido
polished chrome
CR



Cromo satinato
satin chrome
CS



Oro zecchino
gold plated
OZ

modelli / models

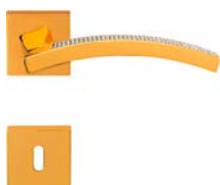

1041 RB 019

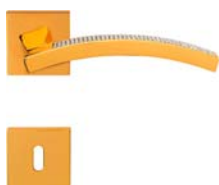
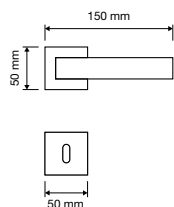

1041 RB 024

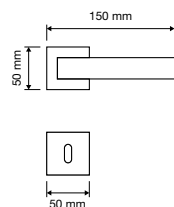

1041 RB 102

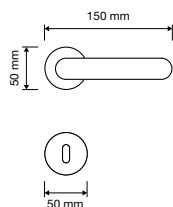

1041 PL

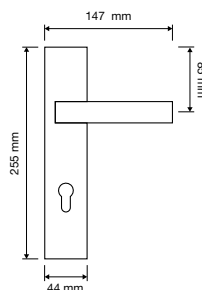

1043 PI

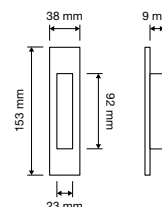

1041 MN 240

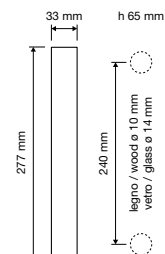

1041 SK

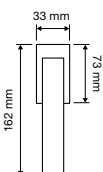

1041 CR

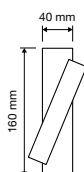

Reflex



Il particolare taglio dei cristalli Swarovski®, studiato per esaltarne i riflessi, rende questa collezione una delle più copiate al mondo.

The particular cut of the Swarovski® crystals, designed to enhance the reflections, make this collection one of the most copied in the world.

made in Italy | patented design





Cromo lucido
polished chrome
CR



Cromo satinato
satin chrome
CS



Oro zecchino
gold plated
OZ

modelli / models



1215 RB 019

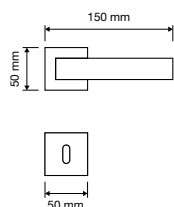

1215 RB 024

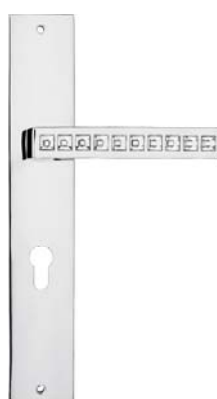
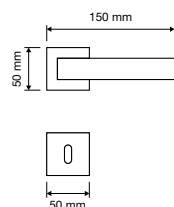

1216 PL

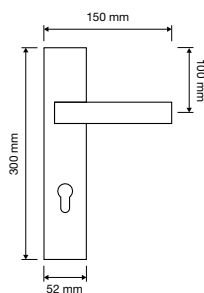

1215 SK

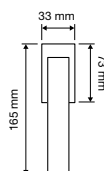

1215 MN 282

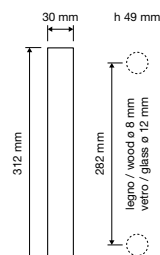

1215 AB

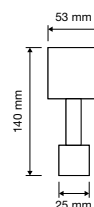

1215 PT

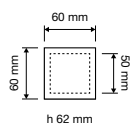

1215 PG 019

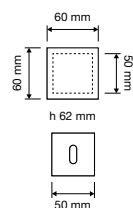

Riflesso Mesh



Il colore profondo e intenso del mare riaffiora alla mente grazie a un particolarissimo pavé di cristalli Swarovski®.

The deep and intense colour of the sea comes to mind thanks to the most particular Swarovski® crystals pavé.

made in Italy | patented design





Cromo lucido
polished chrome
CR



Cromo satinato
satin chrome
CS



Oro zecchino
gold plated
OZ

fantasie / fantasy



Swarovski® mesh cristallo
mesh crystal Swarovski®
1354



Swarovski® mesh cristallo/blu
mesh crystal/blue Swarovski®
1350

modelli / models



1350 RB 019

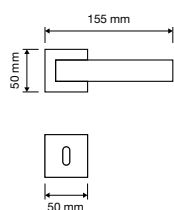

1350 RB 024 <>

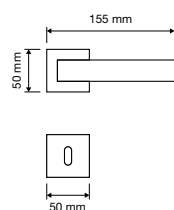

1350 PL

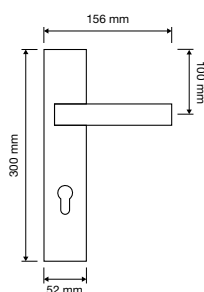

1350 SK 🔒

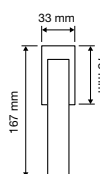

Riflesso Rocks



Un oggetto di uso comune si trasforma in gioiello dalle mille sfaccettature e dagli infiniti riflessi di luce grazie a particolarissimi pavé di cristalli Swarovski®.

An everyday object is transformed into a jewel with infinite reflections and refractions thanks to the very particular pavé Swarovski® crystals.

made in Italy | patented design



finiture / finishing



chromo lucido
polished chrome
CR



chromo satinato
satin chrome
CS



oro zecchino
gold plated
OZ



nero opaco
matt black
VE

finiture / finishing



Swarovski® rocks blue
rocks blue Swarovski®
1351

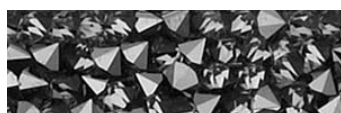

Swarovski® rocks grey
rocks grey Swarovski®
1359

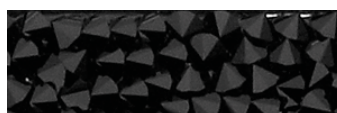

Swarovski® rocks Jet
rocks Jet Swarovski®
1358

modelli / models



1358 RB 019

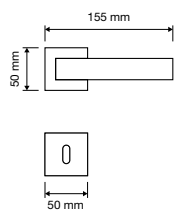

1358 RB 024

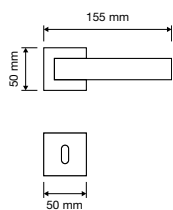

1358 PL

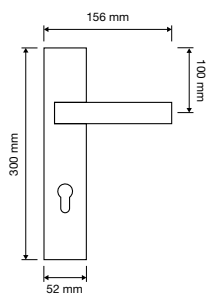

1358 SK

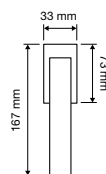

1358 MN 282

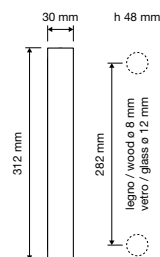

Shell Mesh



Un gioiello proveniente da un vecchio tesoro scoperto su di un'isola deserta, impreziosito da un torchon di cristalli Swarovski®.

A jewel from an old treasure chest discovered on a desert island, embellished with a torchon of Swarovski® crystals.

made in Italy | patented design





cromo lucido
polished chrome
CR



cromo satinato
satin chrome
CS



oro zecchino
gold plated
OZ

modelli / models



694 RB 023

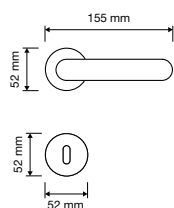

694 RB 025

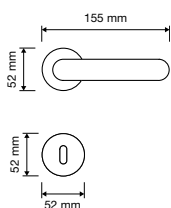

694 PL

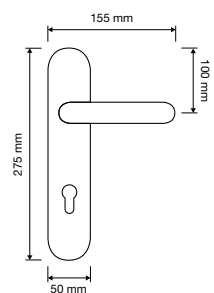

694 SK

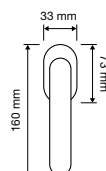

694 MN 248

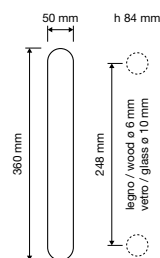

694 PG 023

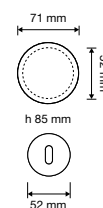

694 PT

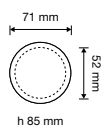

Sintesi Mesh



Un grande pavé di cristalli Swarovski® sottolinea le linee decise e rigorose, nate per distinguersi negli ambienti di design.

The large Swarovski® crystals pavé highlight the decisive and exact lines, created to stand out in designer surroundings.

made in Italy





Cromo lucido
polished chrome
CR



Cromo satinato
satin chrome
CS



Oro zecchino
gold plated
OZ

modelli / models

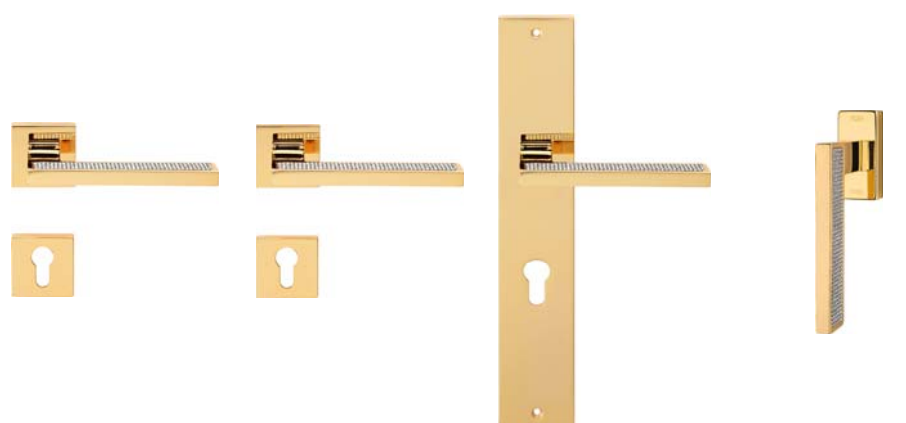

1301 RB 019

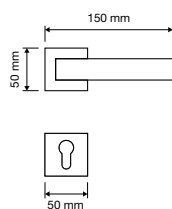

1301 RB 024

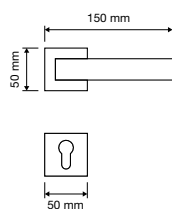

1301 PL

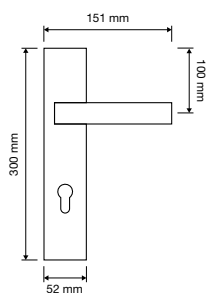

1301 SK

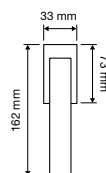

Spirit Mesh



Linee raffinate e sinuose evocano le sensuali calle di Robert Mapplethorpe e disegnano una silhouette classica ma moderna, destinata a rimanere nel tempo.

Refined and sinuous lines evoke the sensual Calla lilies by Robert Mapplethorpe and produce a classical yet modern silhouette, destined to last over time.

made in Italy | patented design



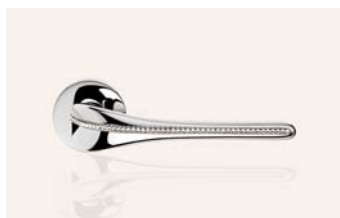

cromo lucido
polished chrome
CR



cromo satinato
satin chrome
CS



oro zecchino
gold plated
OZ



patiné
patiné mat
PM



1451 RB 023

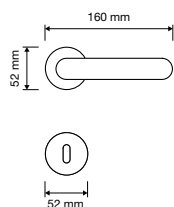

1451 RB 025

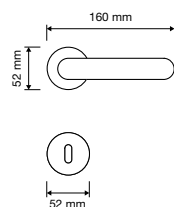

1453 PL

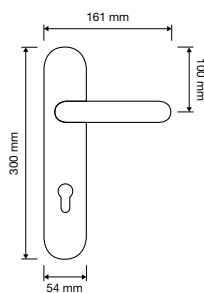

1451 SK

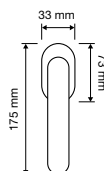

1451 MN 300

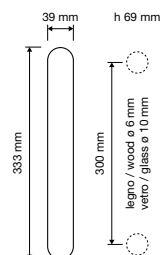

Veronica



Il fascino raffinato e discreto di questa collezione di maniglie si rivela grazie all'impugnatura a clessidra realizzata interamente in cristallo Swarovski®.

The refined and subtle fascination of this collection of handles is revealed thanks to the hourglass handgrip made entirely of Swarovski® crystal.

made in Italy





Cromo lucido
 polished chrome
 CR

Oro zecchino
 gold plated
 OZ

modelli / models



900 RB 103

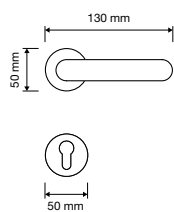

900 PL

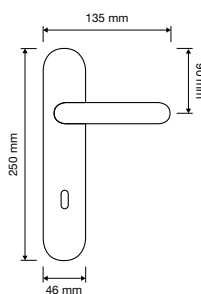

900 SK

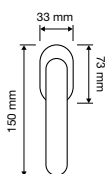

900 PT 080

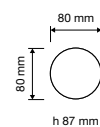

900 PG 103

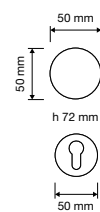

900 MN 208

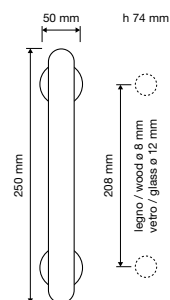

201 PB MM.24

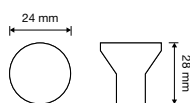

201 PB MM.34

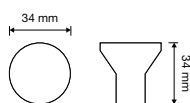

Zen Mesh



Una lunga striscia di piccolissimi cristalli Swarovski® sottolinea il design rigoroso di questa collezione, regalando una luminosità mai vista fino ad ora.

A long band of tiny Swarovski® crystals highlights the meticulous design of this collection, bestowing a radiance unseen until now.

made in Italy





Cromo lucido
polished chrome
CR



Cromo satinato
satin chrome
CS



Oro zecchino
gold plated
OZ

modelli / models

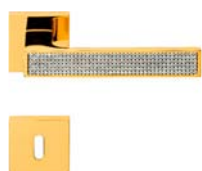

1157 RB 019

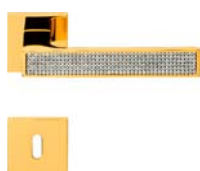
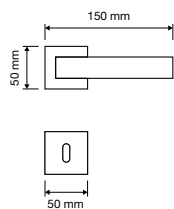

1157 RB 024

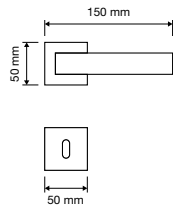

1151 PL

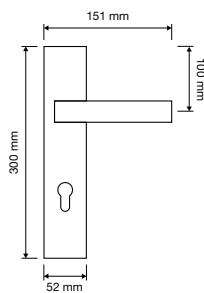

1157 SK

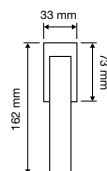

1157 MN 180

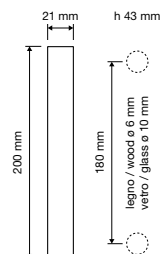

1157 MN 282

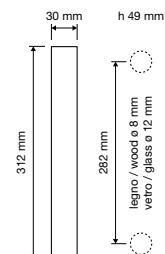



1157 PT

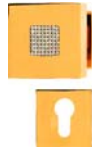
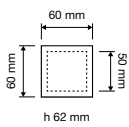

1157 PG 019

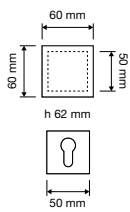

1157 AB

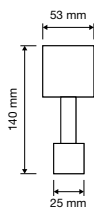

1151 ED/ES

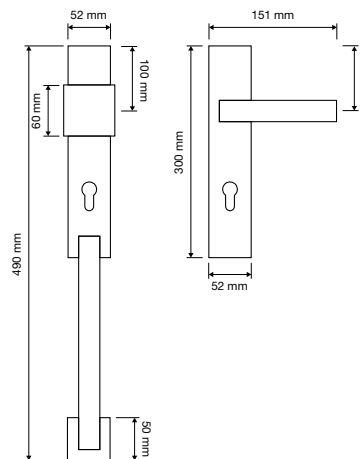

accessories

accessori



Elle | 1050 MN 240
interassi disponibili /
available distances
240 - 320 - 440 - 500 - 800

Elle Pelle | 1052 MN 240

Elle | 1050 MZ 240
interassi disponibili /
available distances
240 - 320 - 440 - 500 - 800

Elle Pelle | 1052 MZ 240

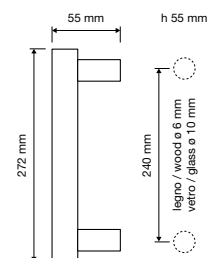
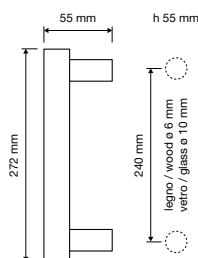
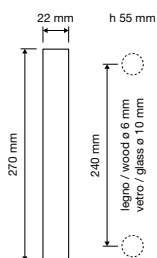
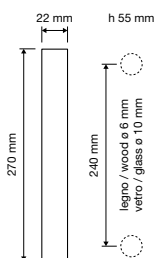
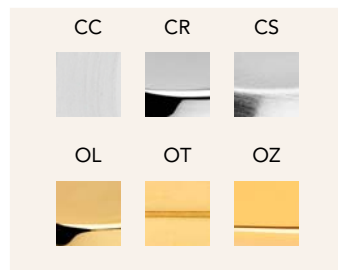
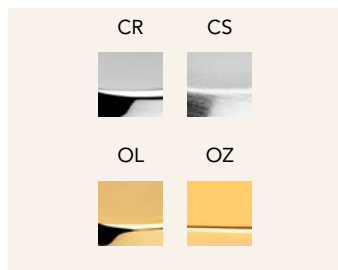
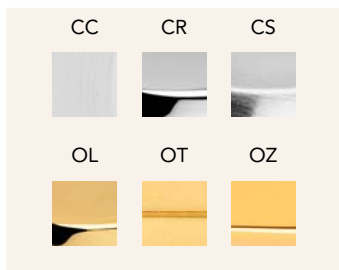

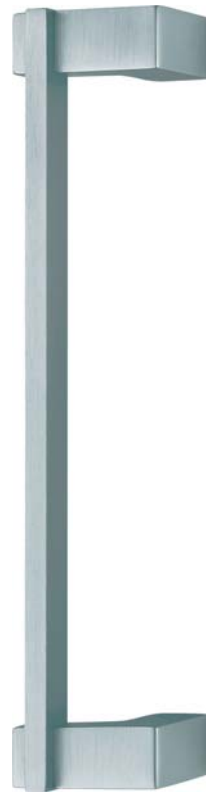

Slim | 1110 MN 240
interassi disponibili /
available distances
240 - 300 - 400 - 600 - 800

Slim Pelle | 1111 MN 240
interassi disponibili /
available distances
240 - 300 - 400 - 600 - 800

Slim | 1110 MZ 240
interassi disponibili /
available distances
240 - 300 - 400 - 600 - 800

Slim Pelle | 1111 MZ 240
interassi disponibili /
available distances
240 - 300 - 400 - 600 - 800

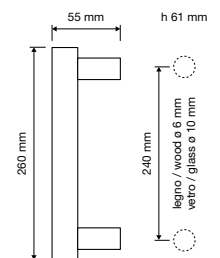
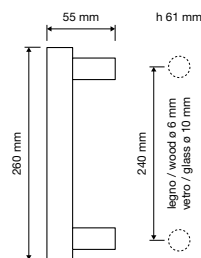
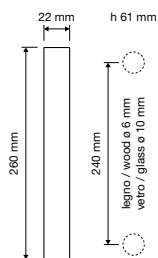
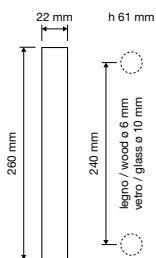
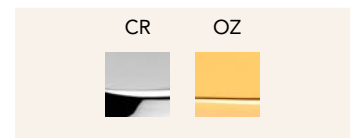
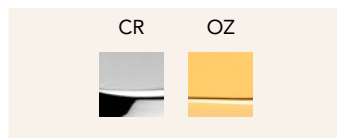



Zen | 1156 MN 282
interassi disponibili / available distances
180 - 282

Thais | 1155 MN 282

Profilo | 1040 MN 240

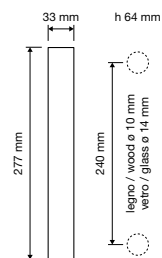
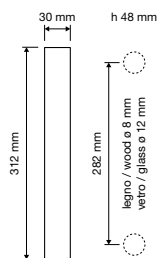
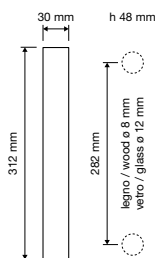
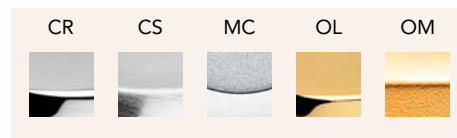
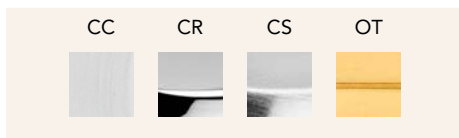
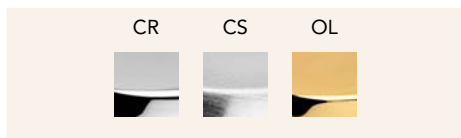



Moma | 1193 MN 240

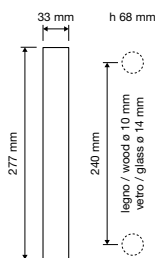

Karina | 942 MN 203

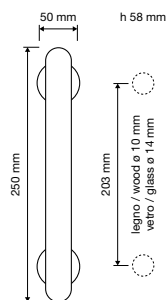

Open | 1105 MN 207

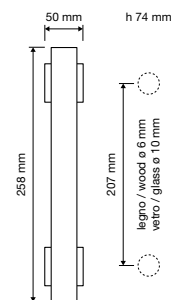
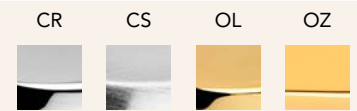



Kendo | 1516 MN 180



Kendo | 1516 MN 390



Kendo | 1516 MZ 300

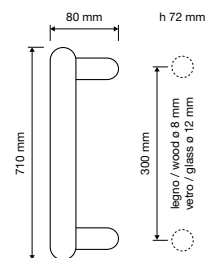
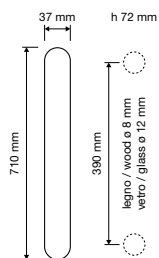
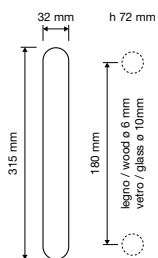
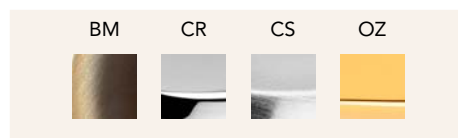



Spirit | 1450 MN 300



Ibis | 691 MN 300



Garda | 670 MN 200

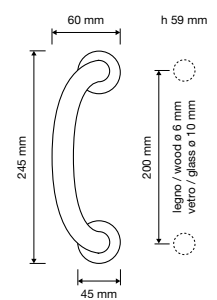
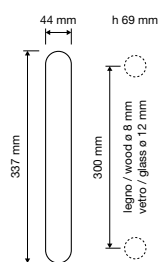
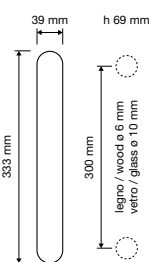
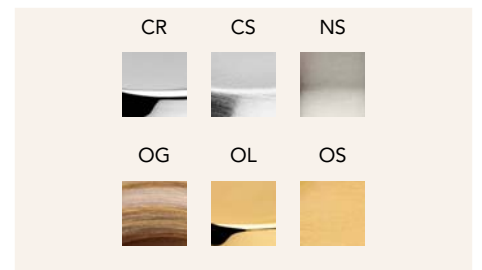
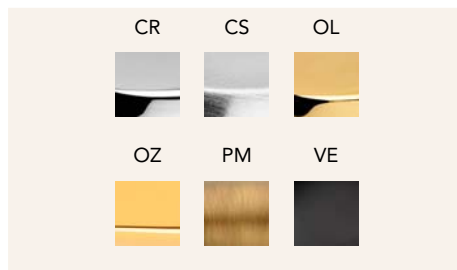
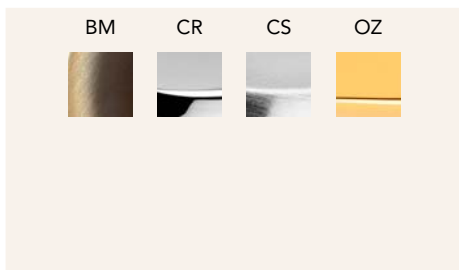



Relax | 1001 MN 200
interassi disponibili / available distances
150 - 200 - 250 - 300

Delfino | 955 MN 240

Sirena | 810 MN 207

OM OZ-RA MC



BM CS MC OL OM



AN OL OZ

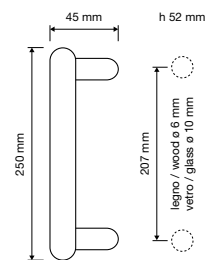
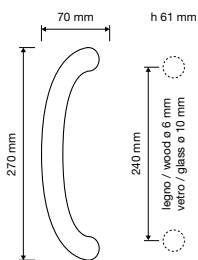
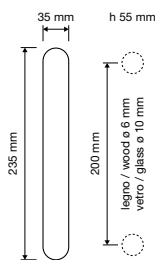



Elika | 990 MN 275



Havana | 1080 MN 267

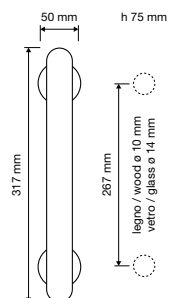
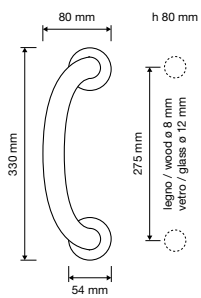
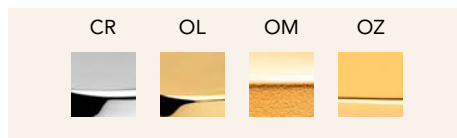
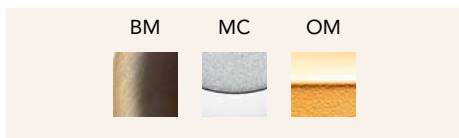



Rose | 996 MN 275

AN BM FV

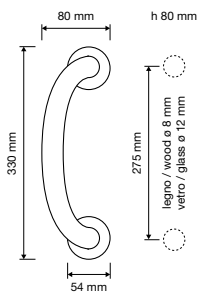

Florenzia | 1460 MN 210

AN FV PM VB

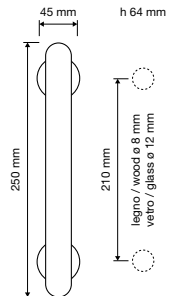

Florenzia | 1460 MZ 198

AN FV OL PM VB

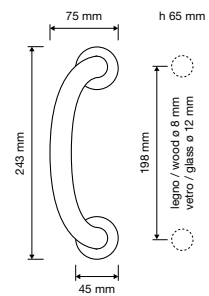



Margherita | 368 MN 240



Dalia | 600 MN 218



Aldar | 920 MN 218

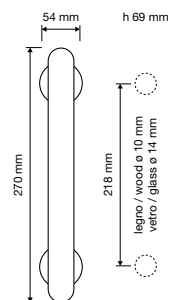
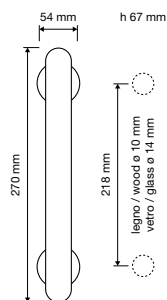
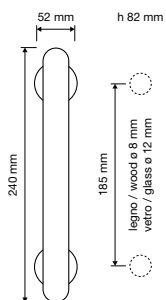
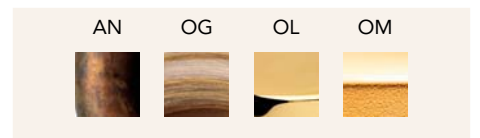
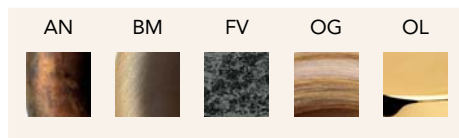
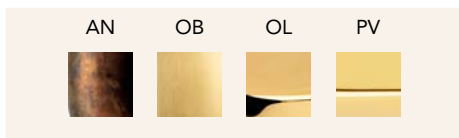



Creative Classic | 1130 MN 380
interassi disponibili / available distances
380 - 550 - 700



Creative Crown | 1144 MN 380
interassi disponibili / available distances
380 - 550 - 700



Marina | 755 MN 320

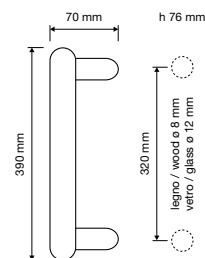
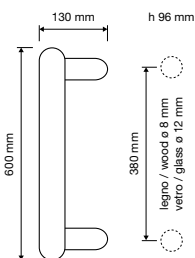
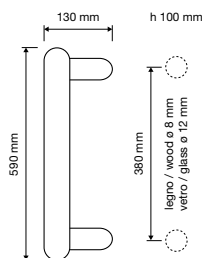
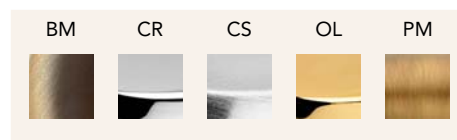
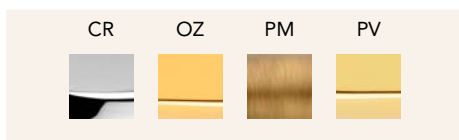



Erica | 1296 MN 218



Tosca | 745 MN 225



Veronica | 900 MN 208

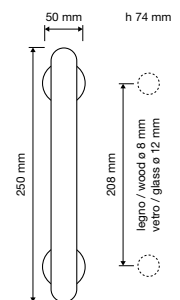
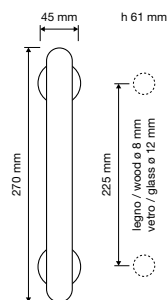
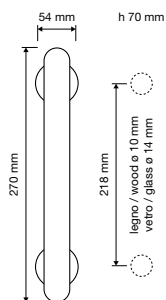
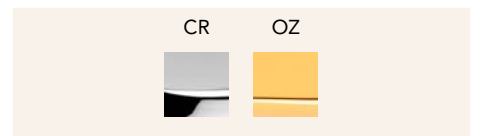
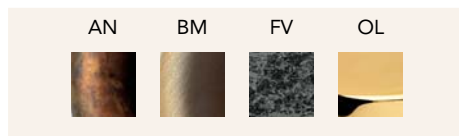
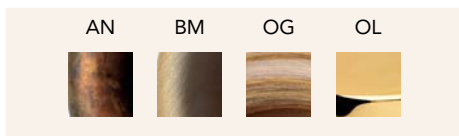



Crystal | 830 MN 236
interassi disponibili / available distances
236 - 310 - 420 - 500

Diamante | 905 MN 210

Elika Crystal | 991 MN 275

CR OZ

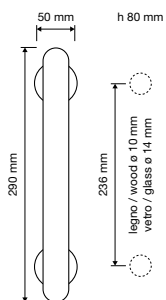

CR OZ

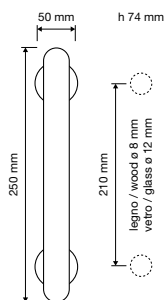

OZ

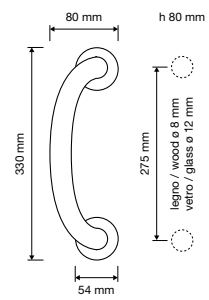



Profilo Mesh | 1041 MN 240

Havana Mesh | 1090 MN 267

Reflex | 1215 MN 282

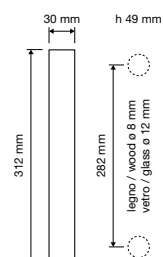
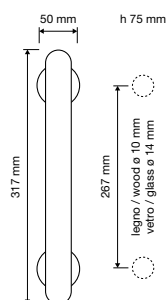
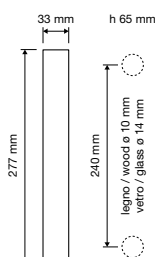
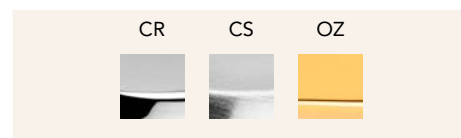
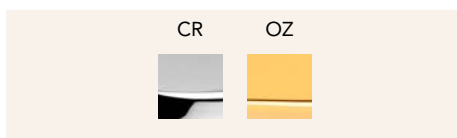



Spirit Mesh | 1451 MN 300

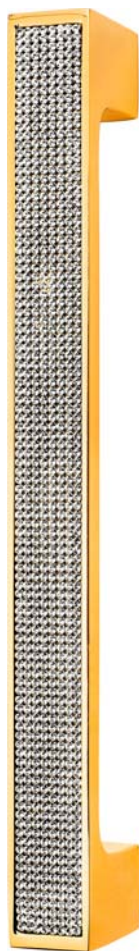

Zen Mesh | 1157 MN 282
interassi disponibili / available distances
180 - 282



Zen Wengé | 1158 MN 282

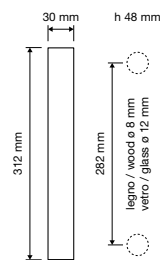
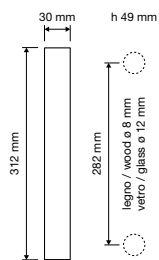
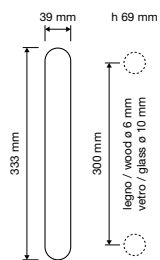
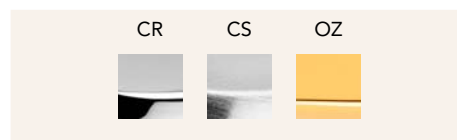
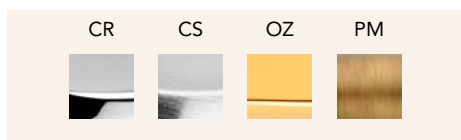



Shell Mesh | 694 MN 248



Luce | 1445 MN 252



Creative Mesh | 1145 MN 380
interassi disponibili / available distances
380 - 550 - 700

CR CS OZ

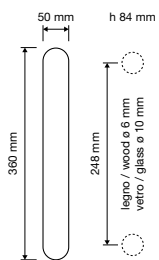
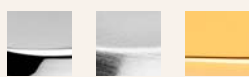

CR CS OZ

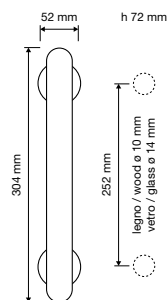
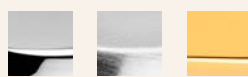

CR OZ

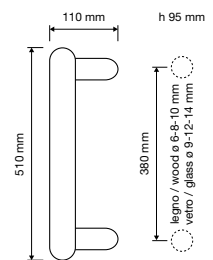



Creative Crystal | 1147 MN 380
interassi disponibili / available distances
380 - 550 - 700



King | 1370 MN 406
interassi disponibili / available distances
406 - 580 - 885



Arte | 1165 MN 796
interassi disponibili / available distances
596 - 796 - 896 - 1196

CR OZ

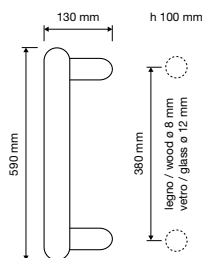

CR OZ

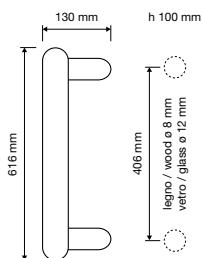

OF OZ PM

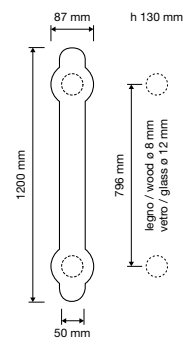



Totem | 1315 MN 800
 interassi disponibili / available distances
 600 - 800 - 900 - 1200



Rococò | 1285 MN 400
 interassi disponibili / available distances
 400 - 500 - 600



Jardin | 1560 MN 400
 interassi disponibili / available distances
 400 - 500 - 600 - 700 - 800

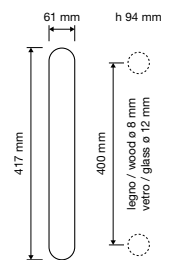
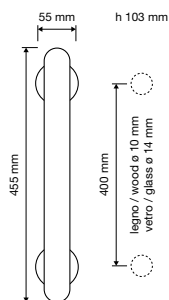
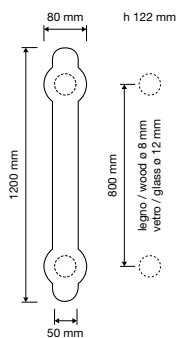
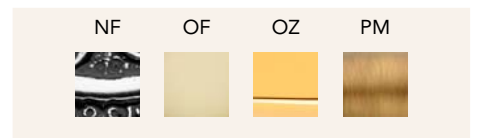
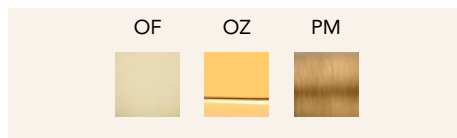
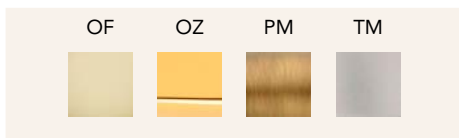



Queen | 1405 MN 315



Queen | 1407 MN 738



Queen | 1408 MN 723

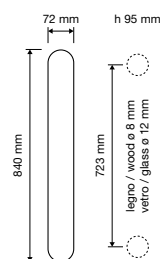
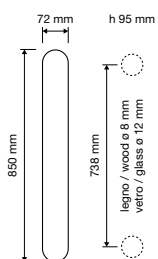
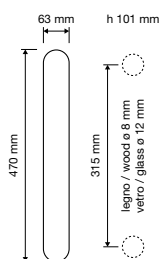



Otello | 1475 MN 500
interassi disponibili / available distances
400 - 500 - 600

Otello Crystal | 1465 MN 500
interassi disponibili / available distances
400 - 500 - 600

Opera | 1055 MN 240

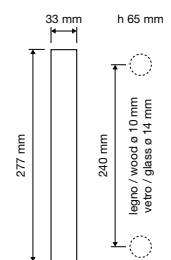
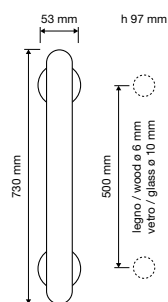
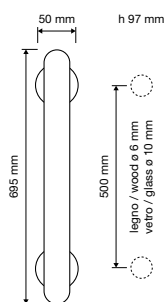
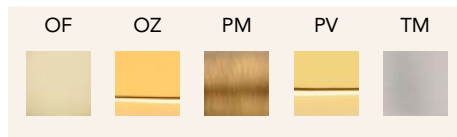
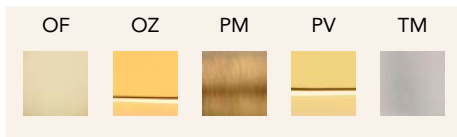



Liberty | 1162 MN 174



Liberty | 1161 MN 234



Liberty | 1160 MN 380
interassi disponibili / available DISTANCES
380 - 500 - 700

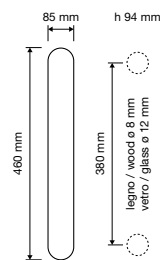
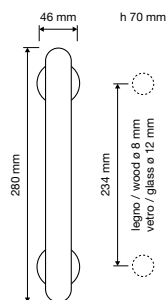
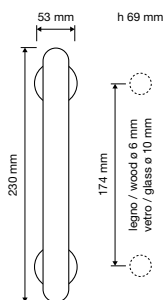
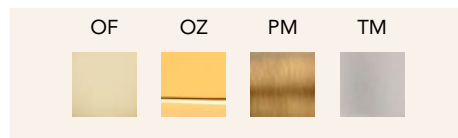
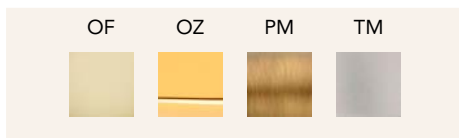
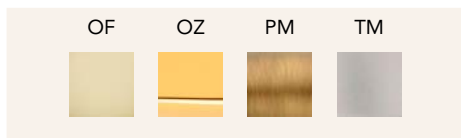



Ninfa | 1540 MN 228



Ninfa Porcellana | 1546 MN 228



Ninfa Crystal | 1542 MN 214

OF OZ PM

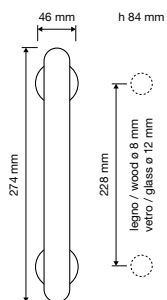

OF OZ PM

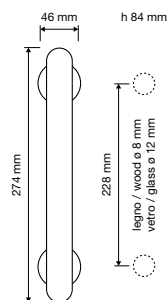

OF OZ PM

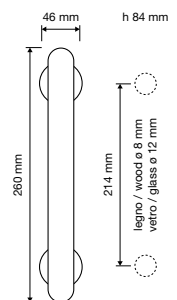



Tiffany | 1308 MN 232

Tiffany Vetro | 1306 MN 232

Tiffany Mesh | 1307 MN 232

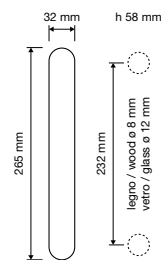
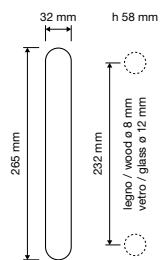
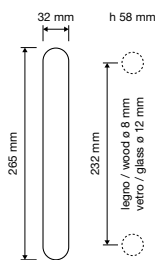
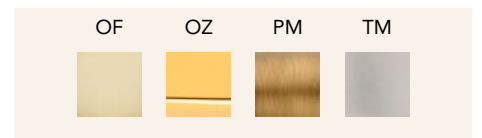
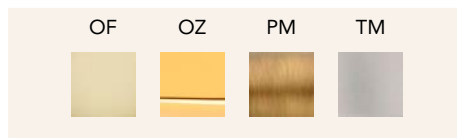
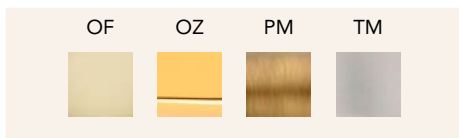



Daisy | 1071 MN 207



Daisy | 1070 MN 275



Frida | 1700 MN 300

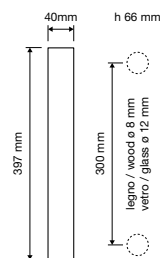
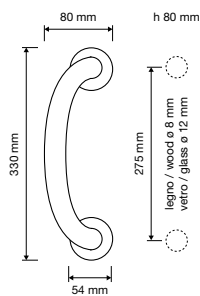
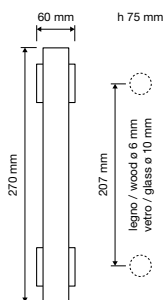
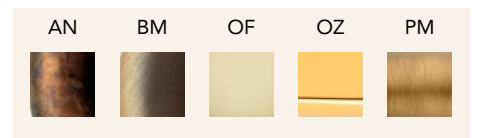



Aisha | 1650 SL



Aisha | 1651 SL



Aida | 1610 MN 172

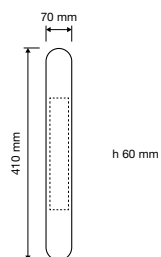
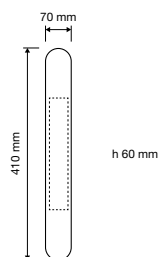
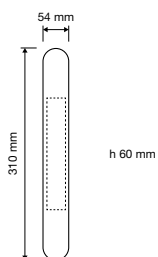
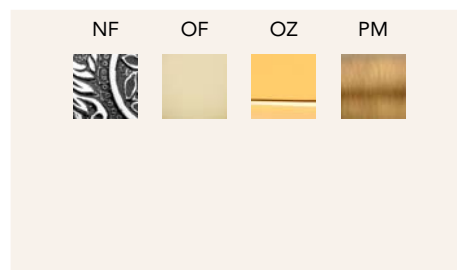
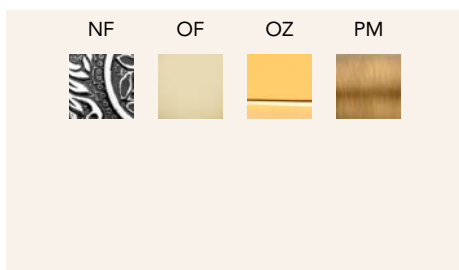
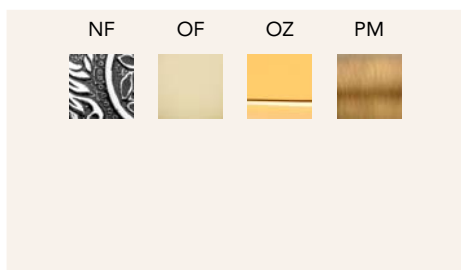



Aida | 1610 SL



Glamor | 1555 MN 300
interassi disponibili / available distances
300 - 400 - 600



Era | 1600 MN 400
interassi disponibili / available distances
300 - 400

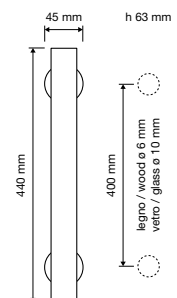
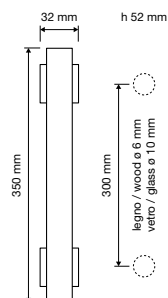
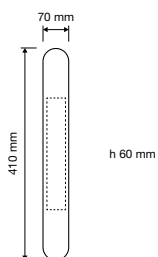
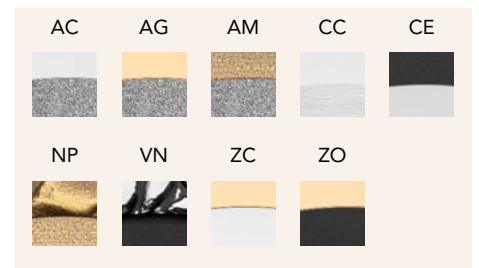
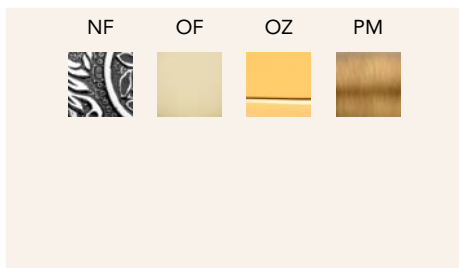

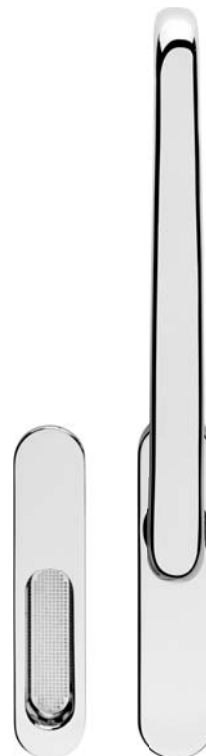
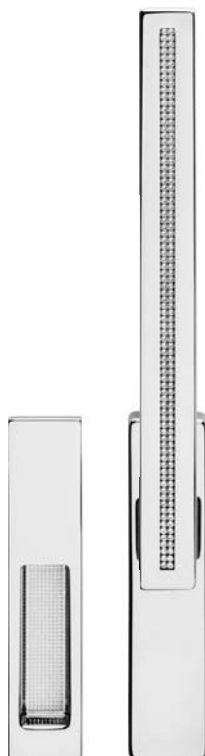
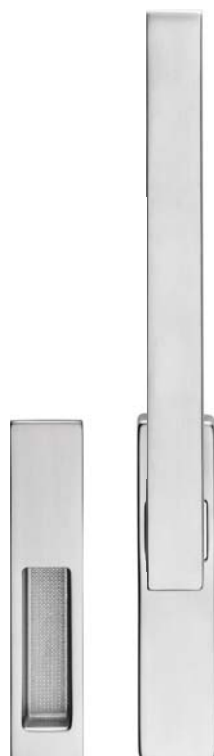

Zen | 1615 MN

Zen Mesh | 1616 MN

Komfort | 1617 MN

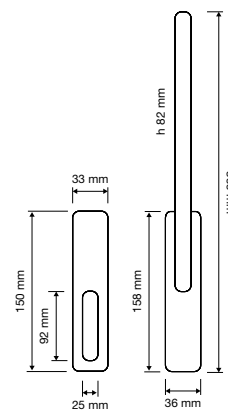
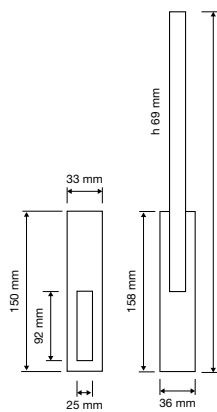
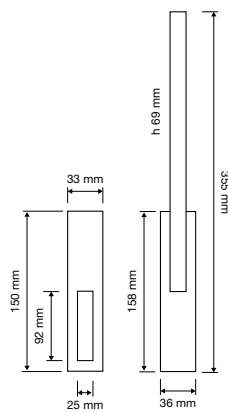
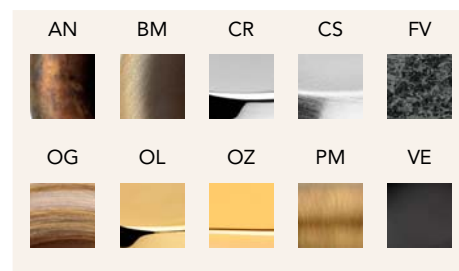
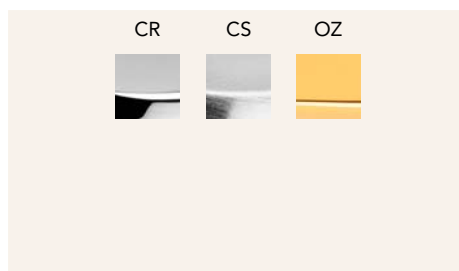
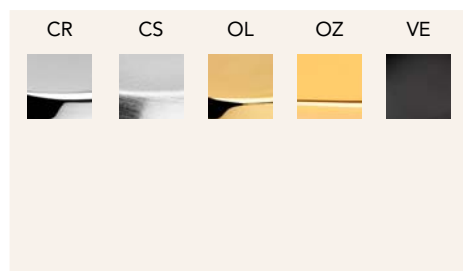

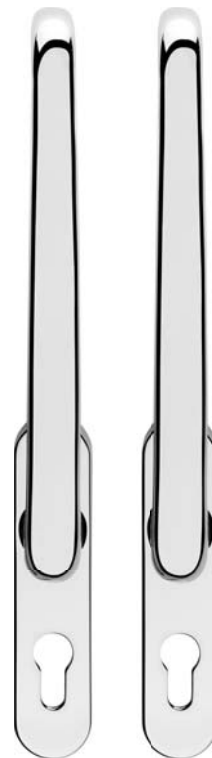
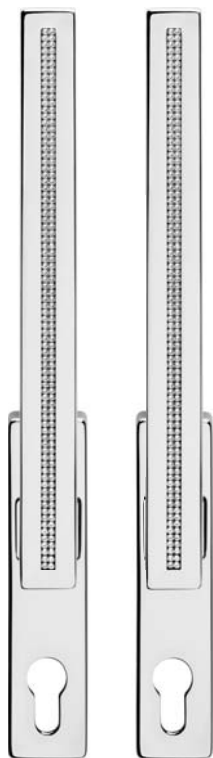
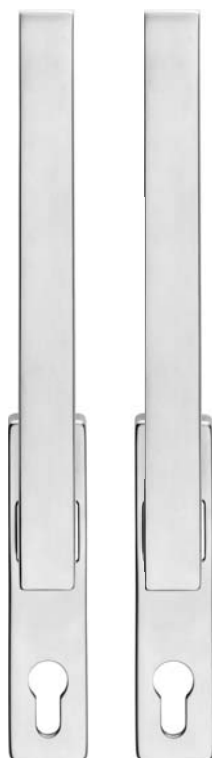

Zen | 1615 MC

Zen Mesh | 1616 MC

Komfort | 1617 MC

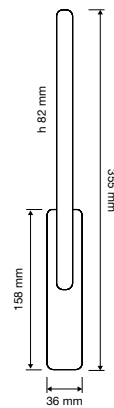
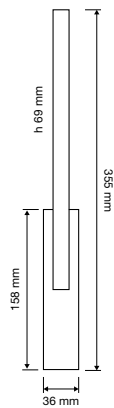
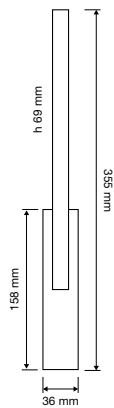
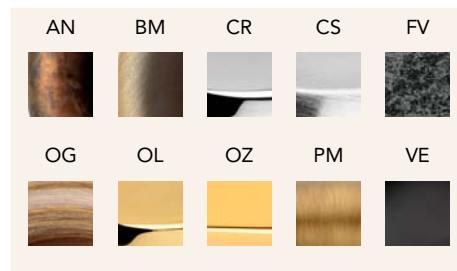
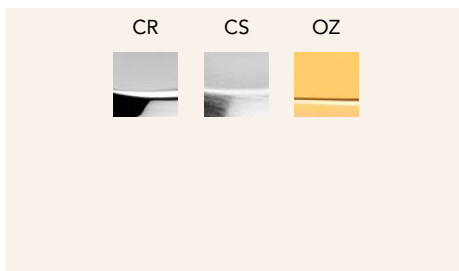
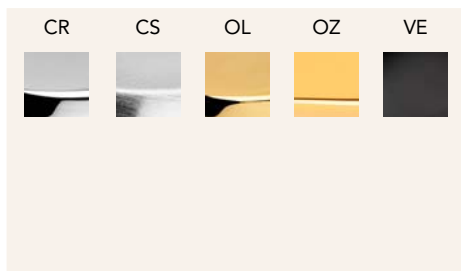



Garda | 400 PT



Giove | 637 PT 070



Brera | 1173 PT

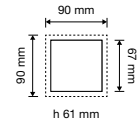
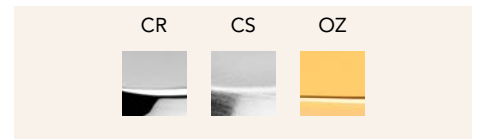
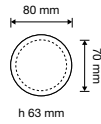
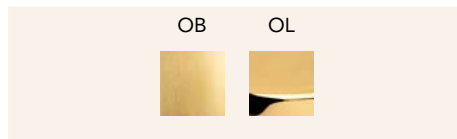
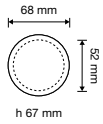
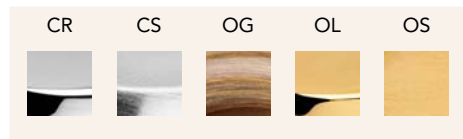

Venere | 410 PT 070



Margherita | 430 PT 070

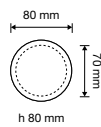
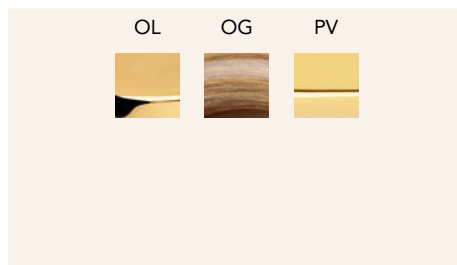
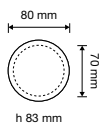



Open | 1105 PT

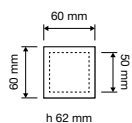

Elika | 990 PT

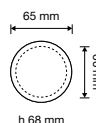

Rose | 996 PT

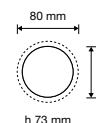

Open | 1105 PG 019



Elika | 990 PG 108



Rose | 996 PG 108



CR CS OL OZ



BM MC OM



AN BM FV

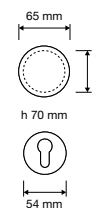
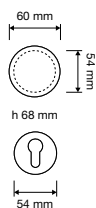
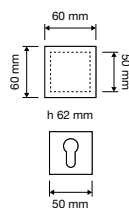



Saba | 401 PT 070

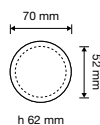

Sfera | 735 PT 070

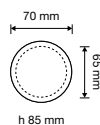

Cuore | 416 PT

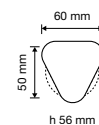

Saba | 441 PG 101



Sfera | 735 PG 101



Cuore | 416 PG 101

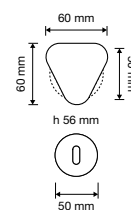
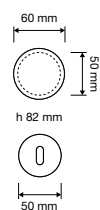
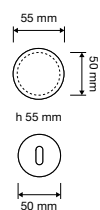
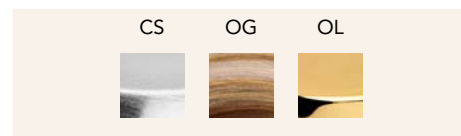
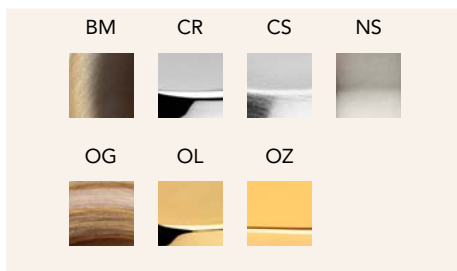
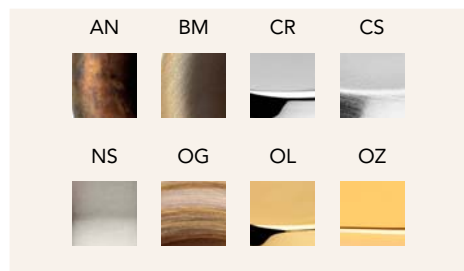



Delfino | 955 PT

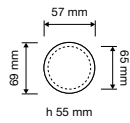

Sirena | 810 PT

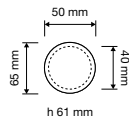

Flavia | 685 RO 102

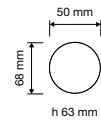

Delfino | 955 PG 102



Sirena | 810 PG 103



Flavia | 685 RB 102

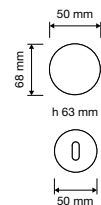
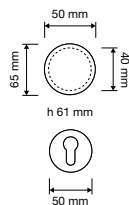
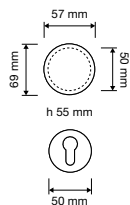
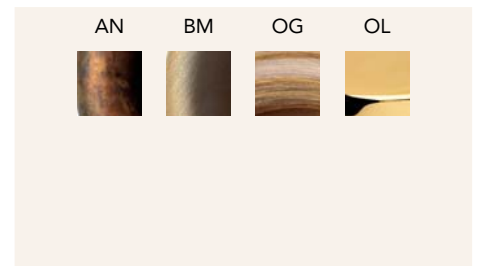
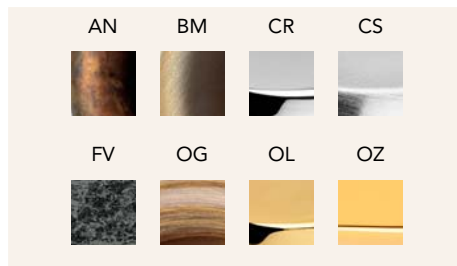
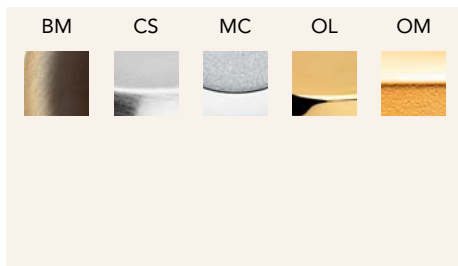



Daisy | 1070 PT



Ninfa | 1540 PT



Opera Crystal | 1056 PT

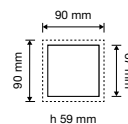
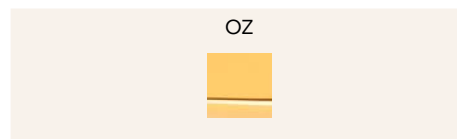
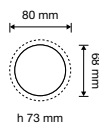
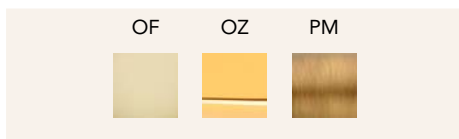
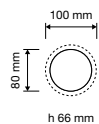

Rococò | 1285 PT



Queen | 1405 PT

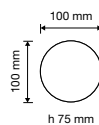
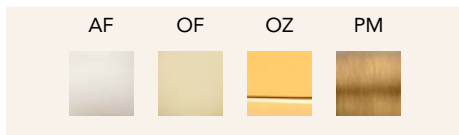
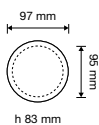
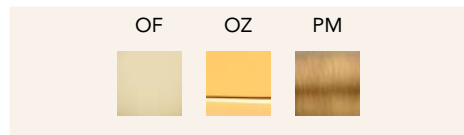



Frida | 1700 PT

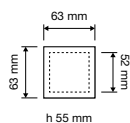

Glamor | 1555 PT

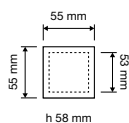

Opera | 1055 PT

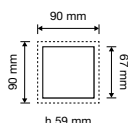

Frida | 1700 PG

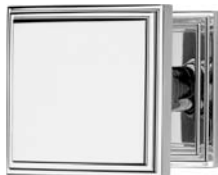
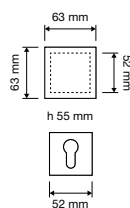

Glamor | 1555 PG

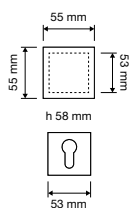

Opera | 1055 PN 060

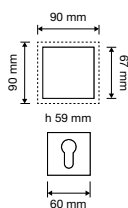



Tiffany | 1308 PT

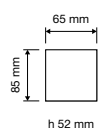

Tiffany Vetro | 1306 PT

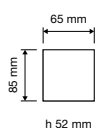

Tiffany Mesh | 1307 PT

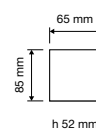

Tiffany | 1308 PG



Tiffany Vetro | 1306 PG



Tiffany Mesh | 1307 PG

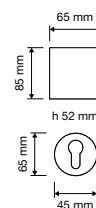
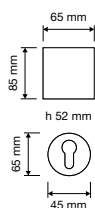
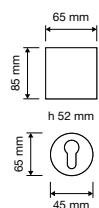
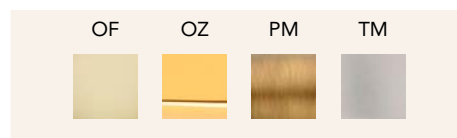
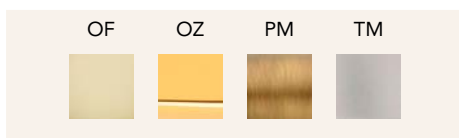
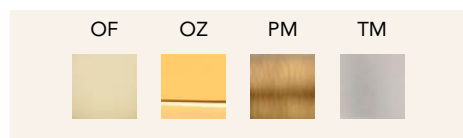



Liberty | 1160 PT

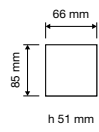

Epoca | 1210 PT

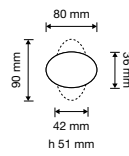

Sissi | 1400 PT 010

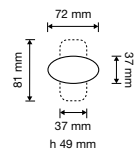

Liberty | 1160 PG

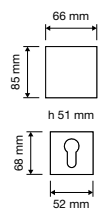

Epoca | 1210 PG

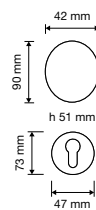

Sissi | 1400 PG 010

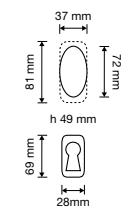

OF OZ PM TM



OF OZ PM



AA OF OO OZ PM

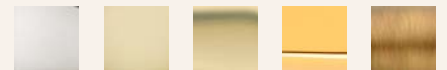



Ninfa Crystal | 1545 PT

OF OZ PM

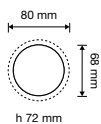

Crystal | 830 PT

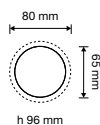

Elika Crystal | 991 PT

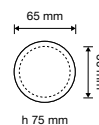

Crystal | 830 PG

CR OZ

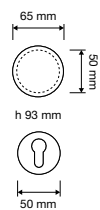

Elika Crystal | 991 PG 108

OZ

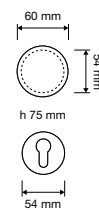

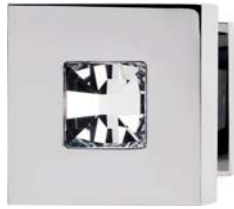

Reflex | 1215 PT

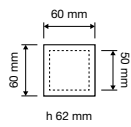

Shell Mesh | 694 PT

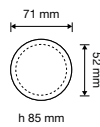

Veronica | 900 PT 080

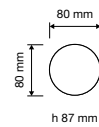

Reflex | 1215 PG 019



CR CS OZ

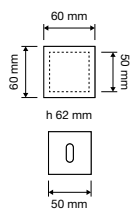
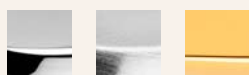

Shell Mesh | 694 PG 023



CR CS OZ

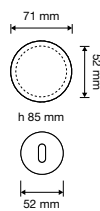

Veronica | 900 PG 103



CR OZ

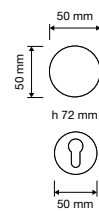



Zen Mesh | 1157 PT

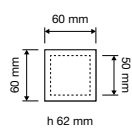

Zen Mesh | 1157 PG 019

CR CS OZ

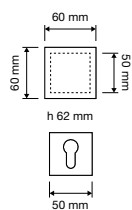
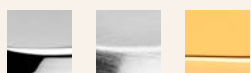



970 BA MC

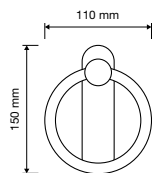

990 BA OM

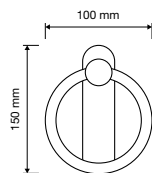

996 BA BM

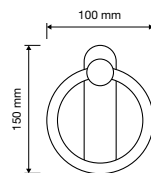

991 BA OZ

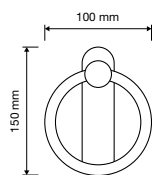

351 BA OL

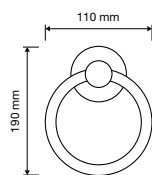

358 BA OL

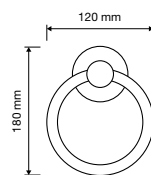



359 BA OL

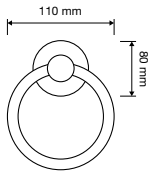

357 BA OL

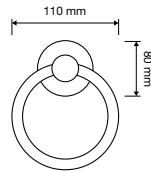

369 BA OL

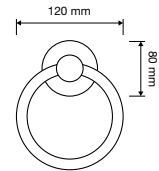

350 BA OL

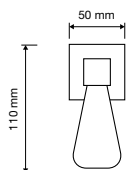

LIBERTY | 1160 BA OF

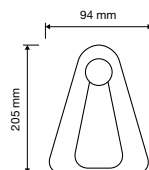

355 BA OL

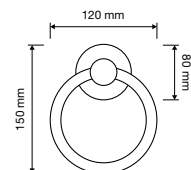

rosetta ribassata reduced rose

Per venire incontro alle ultime tendenze stilistiche, Linea Cali ha dato letteralmente un taglio alle rosette e bocchette tradizionali valorizzando così il design di ogni maniglia.

To meet the latest trends in design, Linea Cali has literally cut the size of traditional roses and escutcheons thus giving more value to the design of every handle.



6 mm

rosetta tradizionale standard rose



10 mm





024 BO 0050 



090 BO 0050



019 BO 0050



025 BO 0052 



023 BO 0052



101 BO 0045



101 BO 0050



109 BO 0045



109 BO 0050





102 BO 0050



103 BO 0050



108 BO 0054



011 BO 0050



096 BO



110 BO 0045



009 BO 0050



010 BO 0069



015 BO 0068





016 BO 0053



018 BO 0065



078 BO 0072



091 BO 0068



112 BO 0054



113 BO 0056



114 BO 0060



115 BO 0055





019 SW



024 SW 



090 SW



023 SW



025 SW 



011 SW



101 SW 0045



101 SW 0050



102 SW





103 SW



108 SW



109 SW 0045



109 SW 0050



008 CV



009 SW



010 SW



015 CV



018 CV



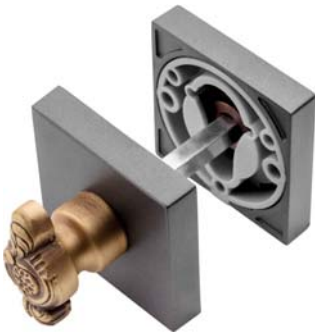

019 CV



078 CV



091 CV



110 SW



113 CV



115 CV



117 NT

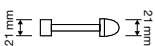

261 NT

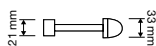

233 NT

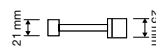

225 NT

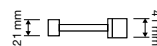



Delfino | 542 CH

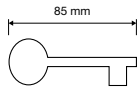

624 CH

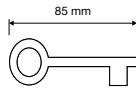

Sirena | 818 CH

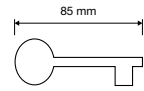

Elle | 1050 CH

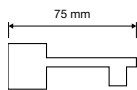

Rose | 543 CH

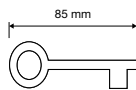



211 FE



613 FE



214 FE

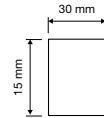

212 FE

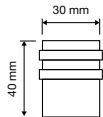

BRERA | 1172 FE

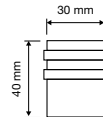

222 FE

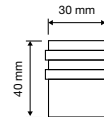

ZEN | 301 FE

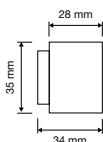

ZEN MESH | 302 FE

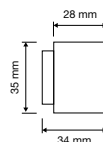

1272 FE





315 CA



316 IV



317 IV



318 IO



139 CP

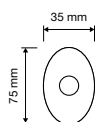

352 CP

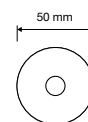

103 CP

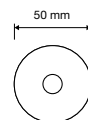

AN



CR



CS



NS



OG



OL

interassi disponibili / available distances

80 - 100 - 120 - 180 - 200 - 250

300 - 350 - 400 - 450 - 600



340 CRMPAE

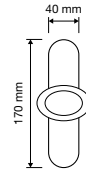

545 CRMPAE

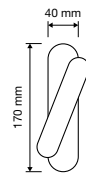

Anello | 340 CRMP 3P2F

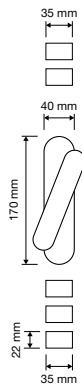



Zen | 1156 AB

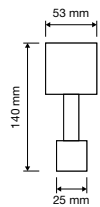

Reflex | 1215 AB

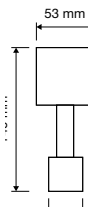

Zen Mesh | 1157 AB

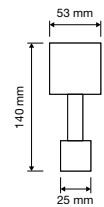

910 AB

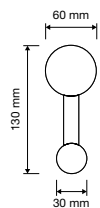

1160 AB

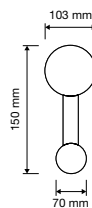

905 AB

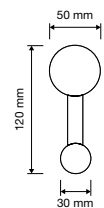



Sfera | 260 B3

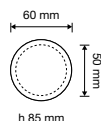

Garda | 400 PT 065

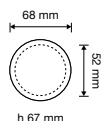

Giove | 259 B3

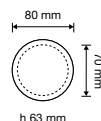

Saba | 401 PT 070

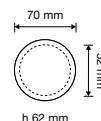

Garda | 258 B2

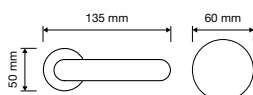

Garda | 255 B2

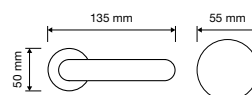

Garda | 252 B1

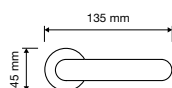



298 B5



297 B5



300 B4

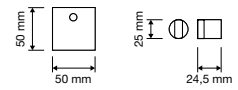

293 B4



294 B4





249 B4



264 B5



262 B4



268 B5 0082 FM11



268 B5 0082 FM16



268 B5 0082 SLIT



268 B7



268 B5 0082 0D



268 B5 0082 0Y



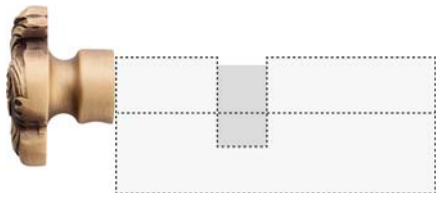

150 B6

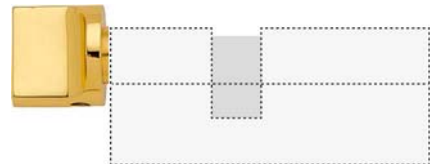
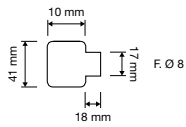

236 B6

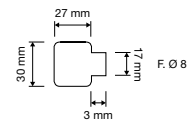

237 B6

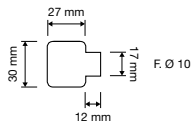

267 B6

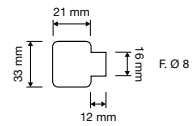

295 B6

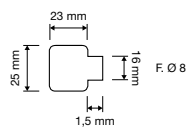

261 B4



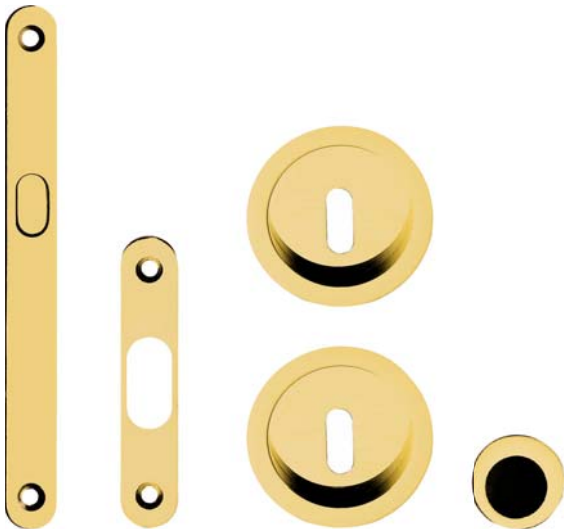

332 KT

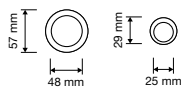

331 KT

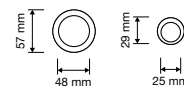

168 PI



169 PI





184 KT

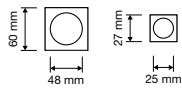

186 KT

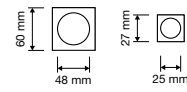

190 PI



189 PI





1277 PI

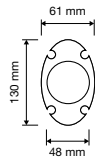

1274 KT

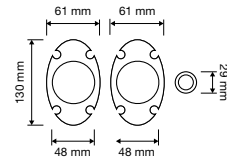

1275 KT

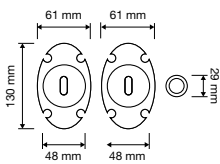

1276 KT

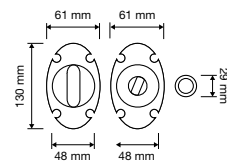

placche incasso / inset handle kit



Brera | 1173 PI

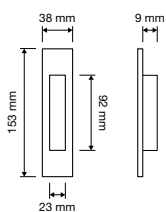

Profilo | 1042 PI

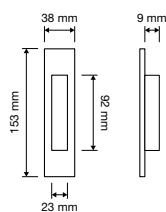

Profilo Mesh | 1043 PI

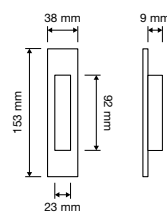

Anna | 849 PI

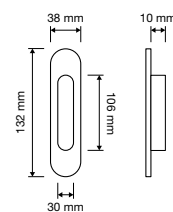

179 PI

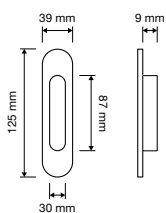

Saba | 629 PI

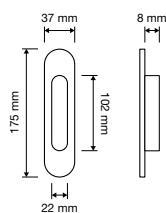

Sirena | 819 PI

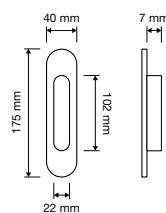

Liberty | 1160 PI

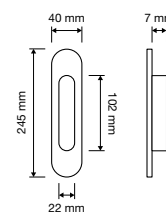

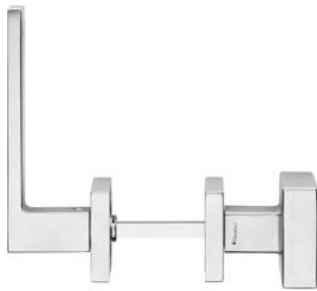

505 SH 019

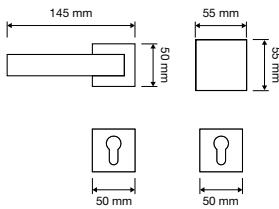

505 RW 019

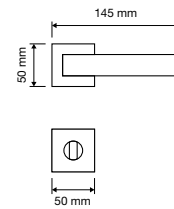

510 KS

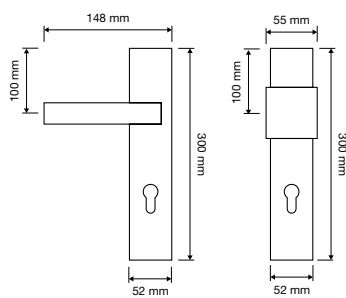

510 PW

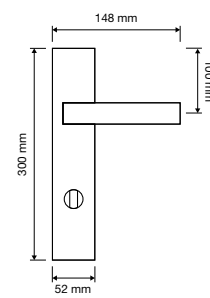

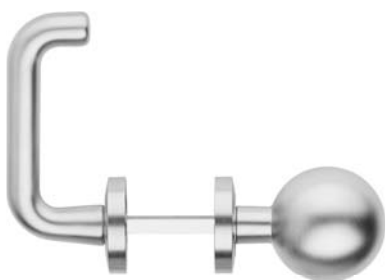

617 SH

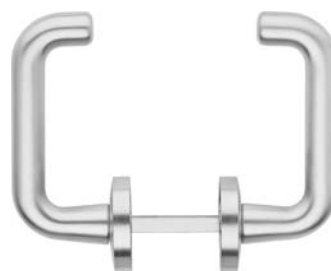
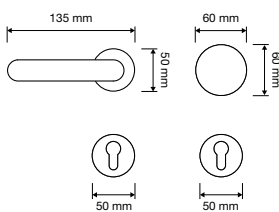

620 RW

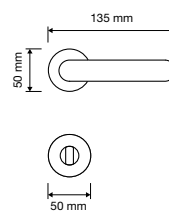

622 KS

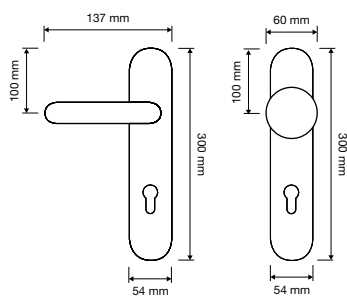

622 PW

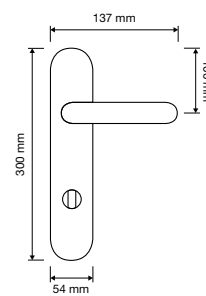



617 KS

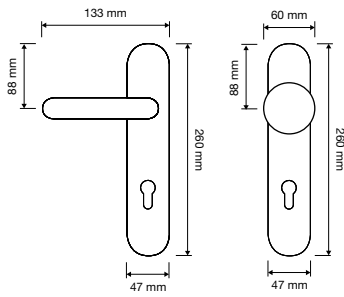

617 PW

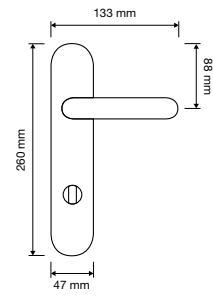



247 CI BM
(Ø int. 20 mm)

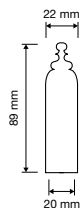

246 CI CS
(Ø int. 16 mm)

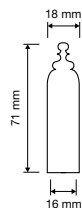

245 CI OG
(Ø int. 14 mm)

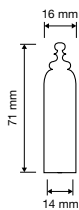

242 CI NS
(Ø int. 20 mm)



241 CI OS
(Ø int. 16 mm)

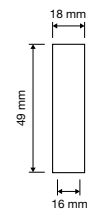

240 CI OL
(Ø int. 14 mm)

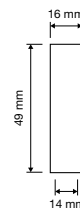

1571 CI 2281 OZ
(Ø int. 20 mm)

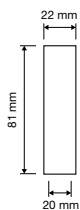

1571 CI 1864 OZ
(Ø int. 16 mm)

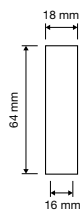

1571 CI 1664 OZ
(Ø int. 14 mm)



1273 CI 1972 OF
(Ø int. 16 mm)

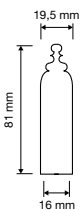

1273 CI 1772 OF
(Ø int. 14 mm)

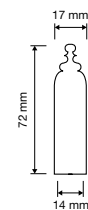



1270 CE

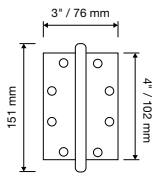

1271 CE

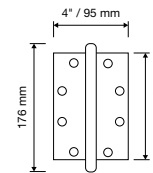

furniture accessories

accessori per mobile

pomoli per mobili / cabinet knobs



Brera Chess
207 PB 0024



Brera Chess
207 PB 0030



Brera Linear
207 PB 0024



Brera Linear
207 PB 0030

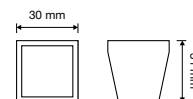
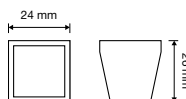
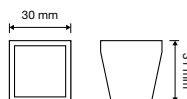
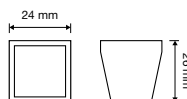
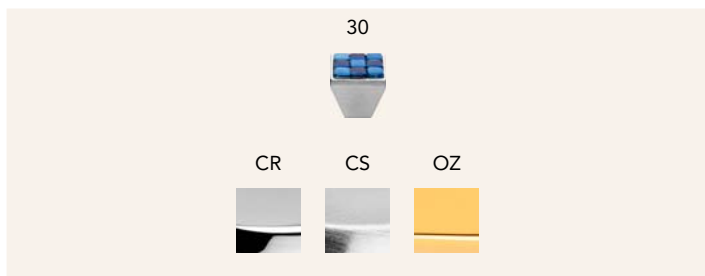

Brera Square
207 PB 0024



Brera Square
207 PB 0030



Brera Stone
207 PB 0024



Brera Stone
207 PB 0030

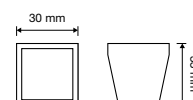
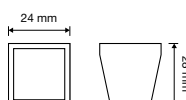
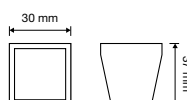
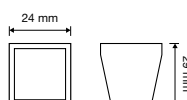
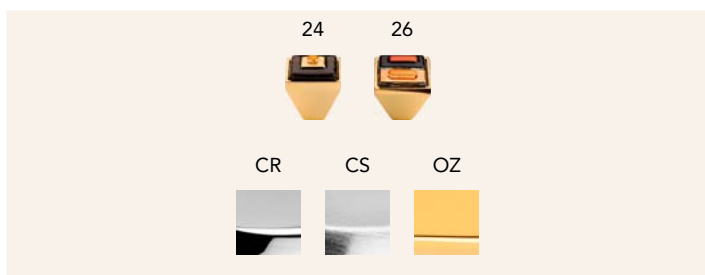



Mesh Crystal
203 PB 0024 0000



Mesh Crystal
203 PB 0030 0000



Mesh Crystal-Blue
203 PB 0024 0057



Mesh Crystal-Blue
203 PB 0030 0057

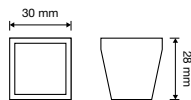
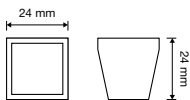
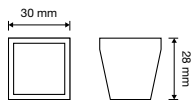
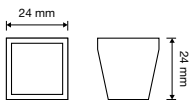
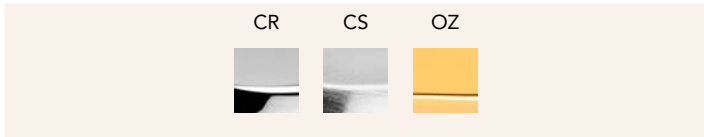

Rocks Black
224 PB 0024 0054



Rocks Black
224 PB 0024 0054



Rocks Grey
224 PB 0030 0055



Rocks Blue
224 PB 0030 0053

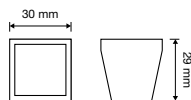
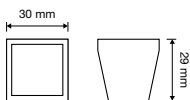
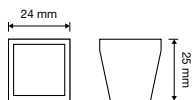
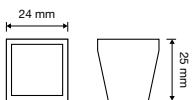

Ring Crystal
320 PB 0024 0000



Ring Black Jet
320 PB 0030 0054

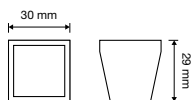
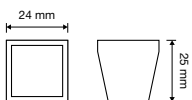
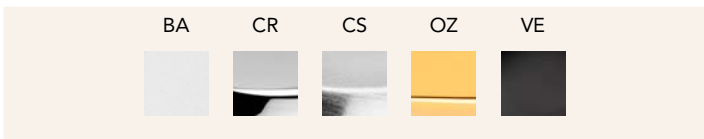

pomoli per mobili / cabinet knobs



Reflex Black Jet
321 PB 0024 0054

Reflex Crystal
321 PB 0024 0000



Elios Crystal
323 PB 0000 0000

Elios Black Jet
323 PB 0000 0054

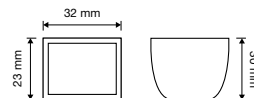
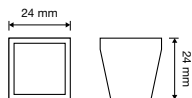
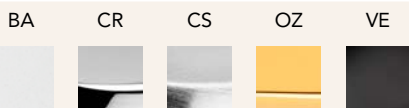

Pop-Art Crystal
205 PB 0030 0000



Mirror Crystal
204 PB 0030 0000

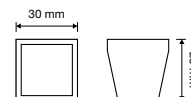
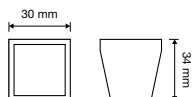

Cometa Crystal
324 PB

Cometa Crystal
324 PB



Ellipse Crystal
322 PB

Ellipse Crystal
322 PB

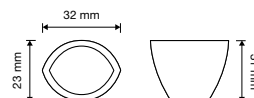
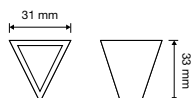
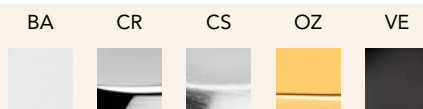



Diamante Crystal
206 PB 0024

Diamante Crystal
206 PB 0024

Veronica Crystal
201 PB 0024

Veronica Crystal
201 PB 0034

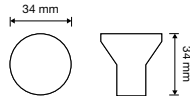
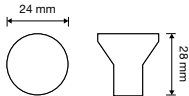
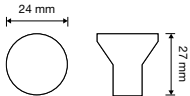
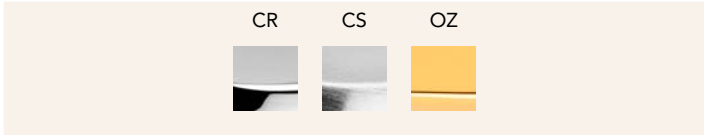

Cosmic Crystal
209 PB 0022 0000

Cosmic Crystal
209 PB 0030 0000

Crystal | 0000

Crystal Verde
Green | 0051

Crystal Viola
Violet | 0052

Crystal Topazio
Topaz | 0050

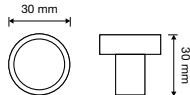
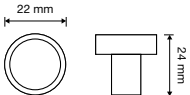
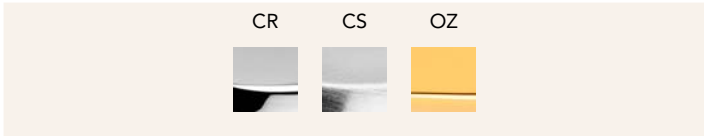

Crystal
200 PB 0020

Crystal
200 PB 0030

Crystal
200 PB 0040

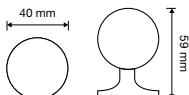
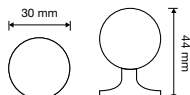
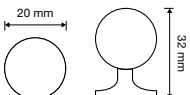



Frida
1700 PB 0031

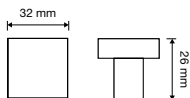
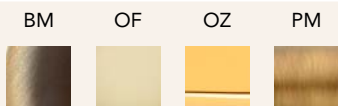

Daisy
1070 PB 0030

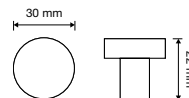
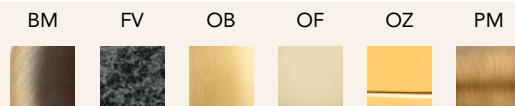

Rose
996 PB 0030

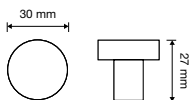

Sirena
202 PB 0027



Sirena
202 PB 0032

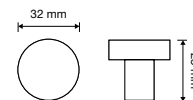
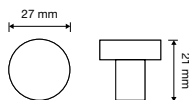
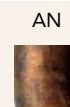

Vintage
1272 PB

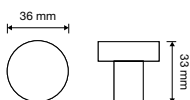
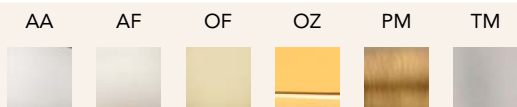



Vintage
1278 MB 0064



Vintage
1278 MB 0096



Vintage
1278 MB 0128

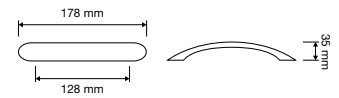
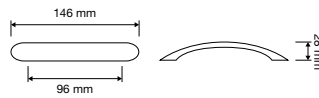
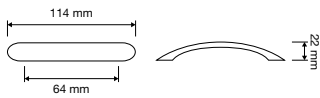
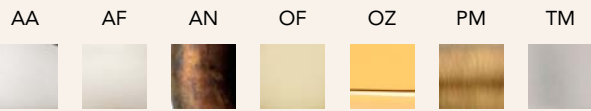

Rococò
1285 MB 0064



Rococò
1285 MB 0096



Rococò
1285 MB 0128

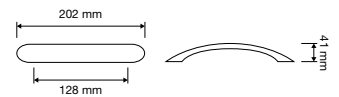
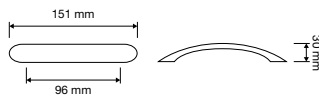
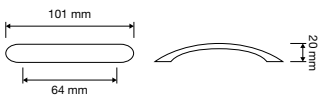
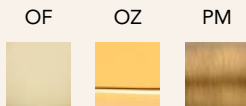

Frida
1700 MB 0096

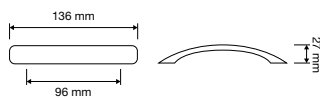
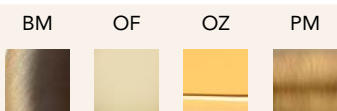



adesivo trasparente / transparent sticker
ADR 500

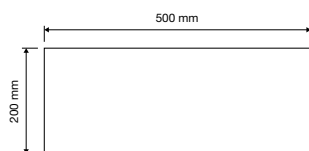

adesivo trasparente / transparent sticker
ADR 300

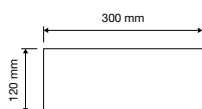

adesivo / sticker
ADT 060





vetrofanía bifacciale
window decals
Fish Crystal | VET 001

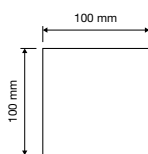

vetrofanía bifacciale
window decals
Liberty | VET 002

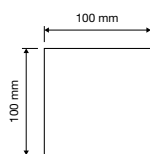

vetrofanía bifacciale
window decals
Marina | VET 003

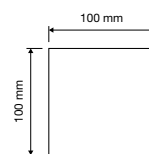

vetrofanía bifacciale
window decals
Rombo | VET 004

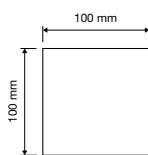

vetrofanía bifacciale
window decals
Shell Mesh | VET 005

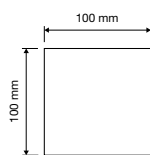

vetrofanía bifacciale
window decals
Sissi | VET 006

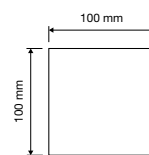



espositore da parete
wall display
064 AC

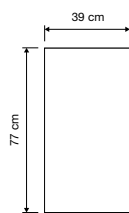

espositore da pavimento bifacciale
floor display
061 AC

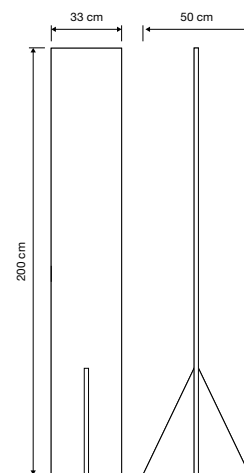



espositore da parete (6 collezioni)
wall display (6 collections)
066 AC

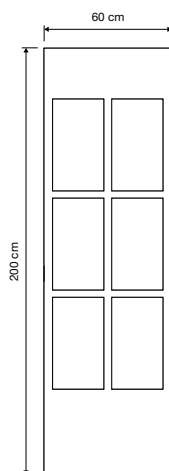

espositore da pavimento (12 collezioni)
floor display (12 collections)
065 AC

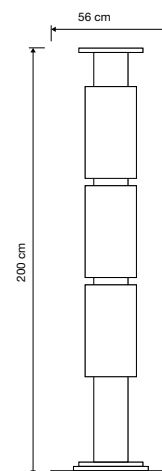



espositore da BANCO
counter display
070 AC

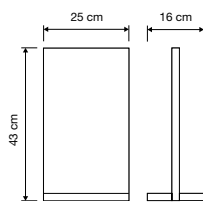

espositore smartblock
smartblock display
071 AC

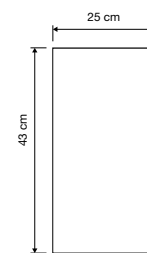

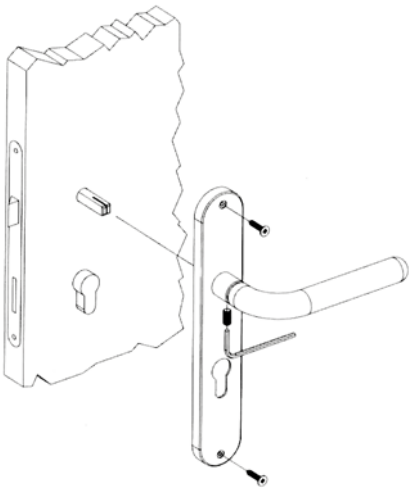

sistema di montaggio per maniglia con placca / fixing system for door handle on plate

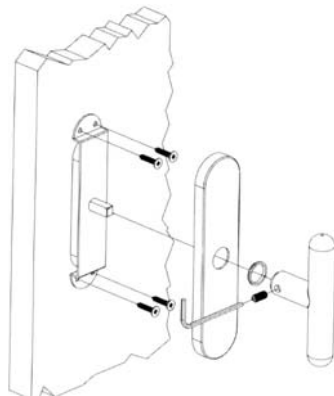

sistema di montaggio maniglia per finestra / fixing system for window handle

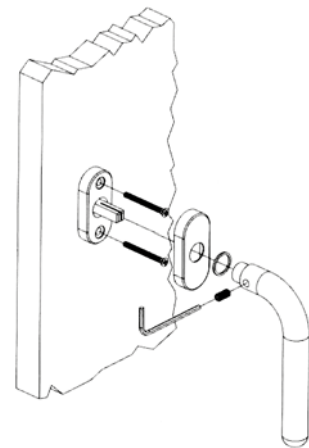

sistema di montaggio maniglia per finestra con movimento 4 scatti / fixing system for window pull, 4 clicks positions

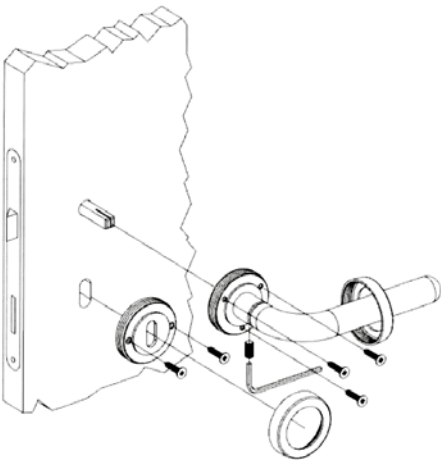

sistema di montaggio per maniglia con rosetta / fixing system for door handle on rose

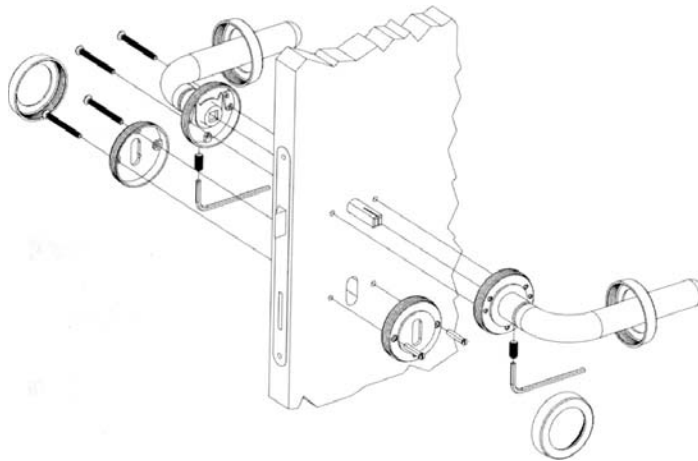

sistema di montaggio con viti passanti (m3) per maniglia con rosetta / through assembly (m3 screws) for door handles on rose

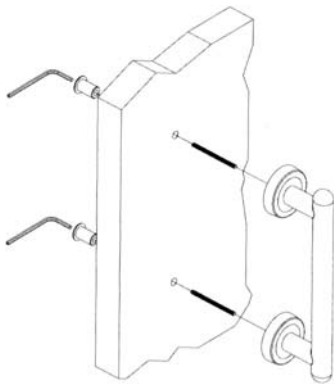

sistema di fissaggio singolo maniglione su porta in legno (maniglioni con rosette art.102-103-113) / fixing system for a single pull handle on a wooden door (pull handles with rose art.102-103-113)

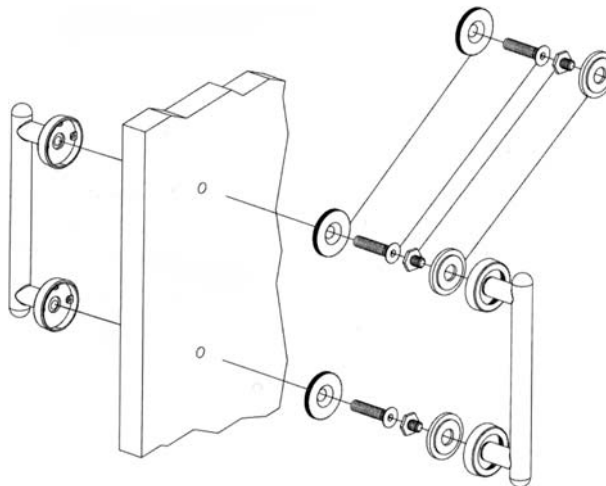

sistema di fissaggio di una coppia di maniglioni su porta legno (maniglioni con rosette art.102-103). accessori da ordinare separatamente (rif. listino prezzi art.118mn) / system for fixing a pair of pull handles on a wooden door (pull handles on rose art.102-103). fixing accessories to order separately (ref. price list art.118mn)

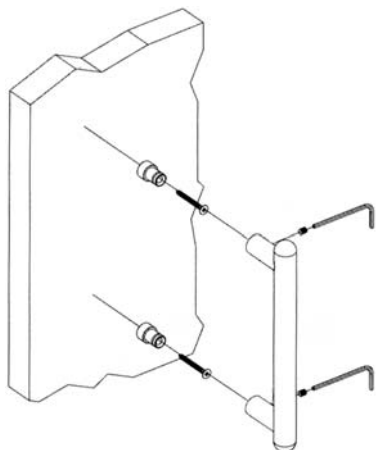

sistema di fissaggio singolo maniglione su porta in legno / fixing system for a single pull handle on a wooden door

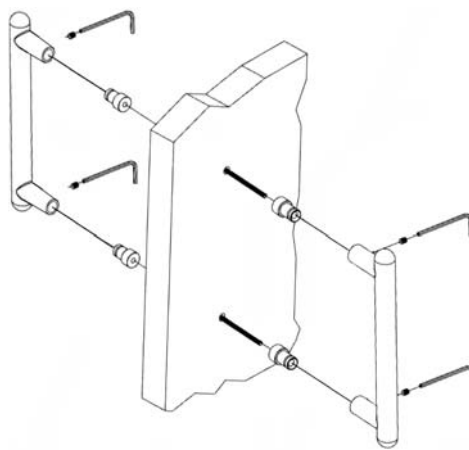

sistema di fissaggio di una coppia di maniglioni su porta legno / system for fixing a pair of pull handles on a wooden door

CLICK-CLACK European profile cylinder

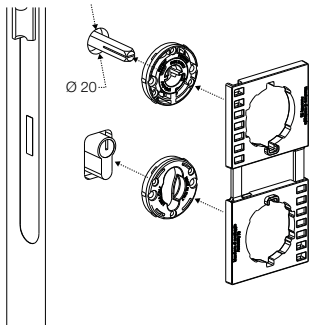

STEP 1/3

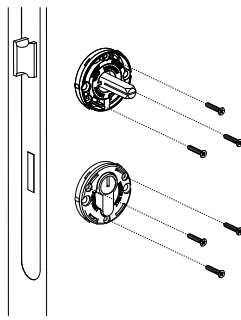

STEP 2/3

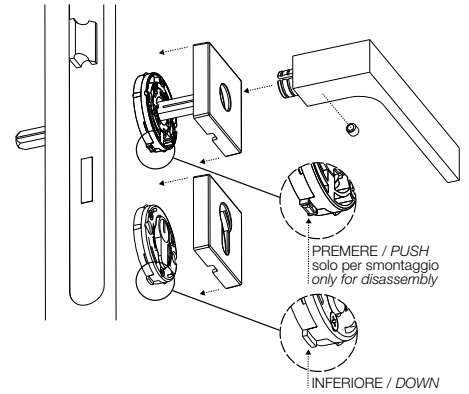

STEP 3/3

CLICK-CLACK Patent key

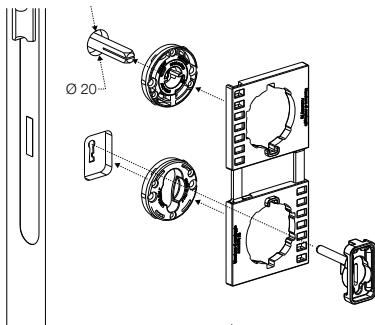

STEP 1/3

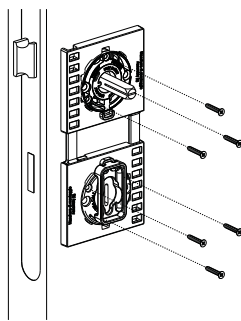

STEP 2/3

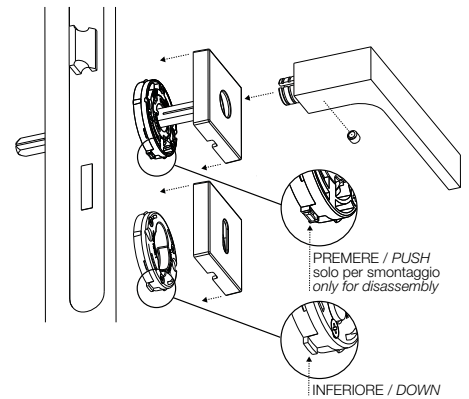

STEP 3/3

CLICK-CLACK Toilet

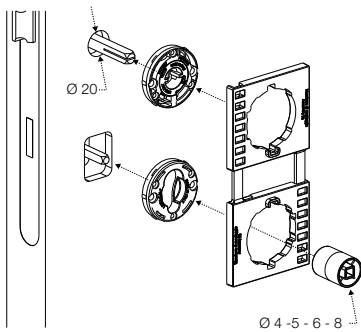

STEP 1/3

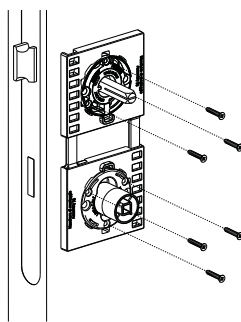

STEP 2/3

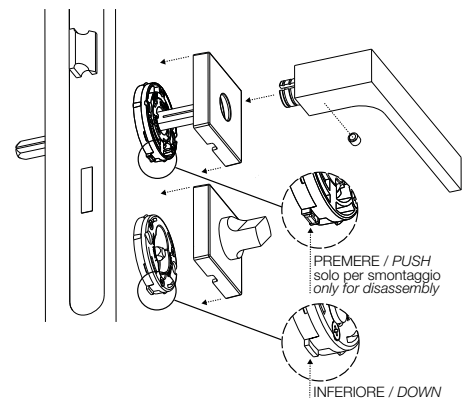

STEP 3/3

istruzioni di montaggio / mounting instructions

posizionamento e fissaggio con dima per esecuzione fori passanti interasse 38mm / fixing system with drilling jig for bolt through holes 38mm distance

CLICK-CLACK European profile cylinder

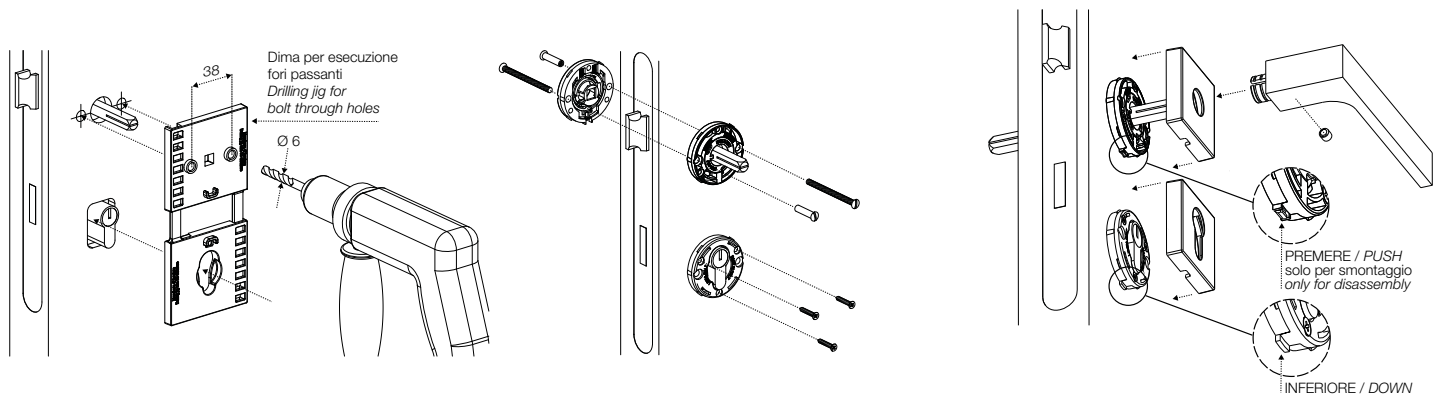

STEP 1/3

STEP 2/3

STEP 3/3

CLICK-CLACK Patent key

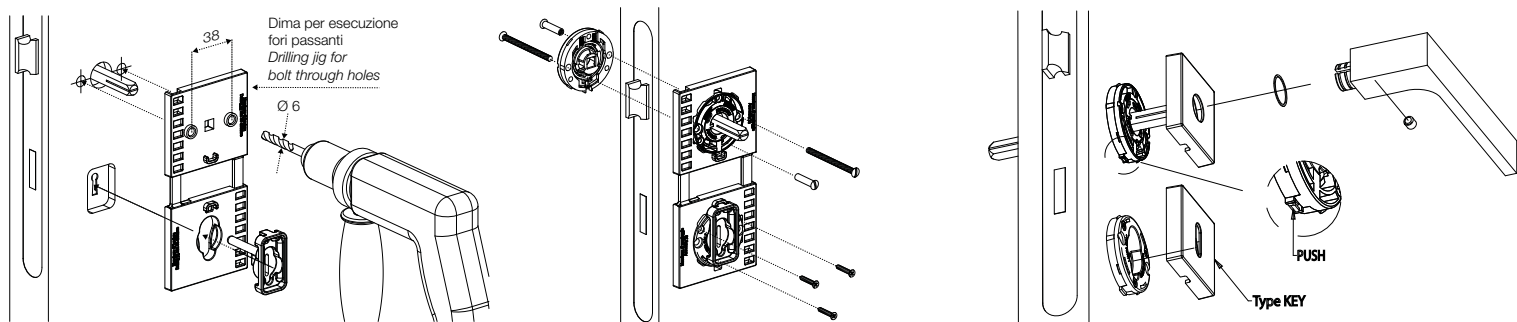

STEP 1/3

STEP 2/3

STEP 3/3

CLICK-CLACK Toilet

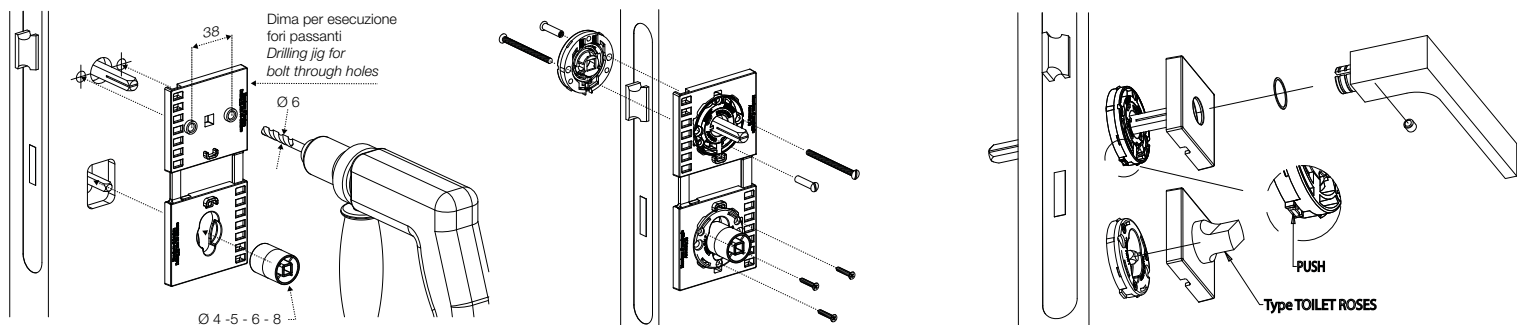

STEP 1/3

STEP 2/3

STEP 3/3

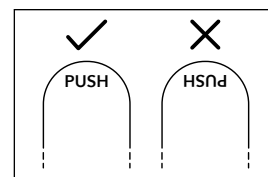
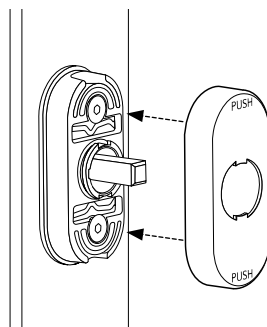
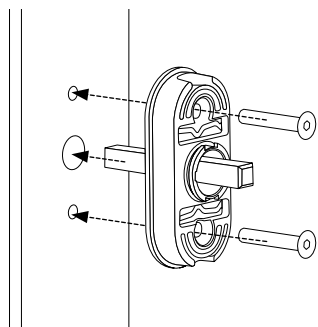

STEP 1/4

STEP 2/4

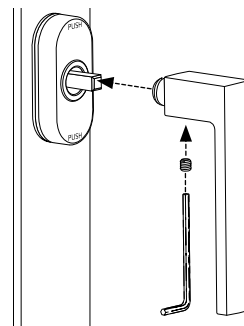
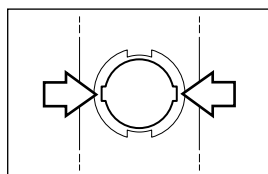
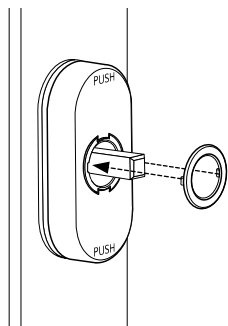

STEP 3/4

STEP 4/4

istruzioni d'uso / instructions for use

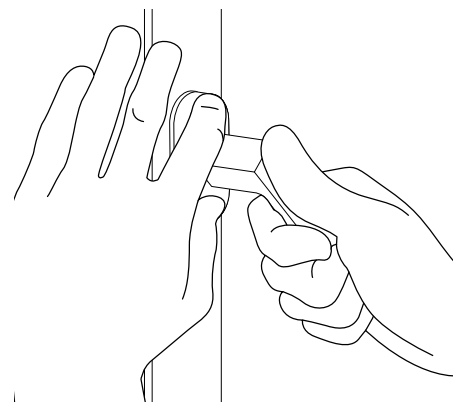
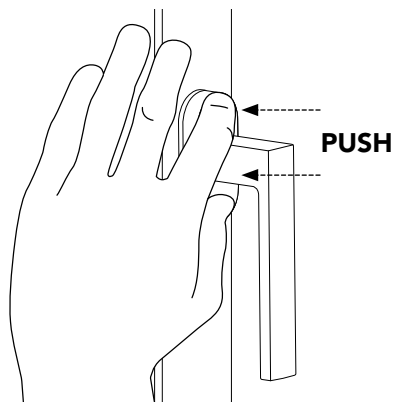
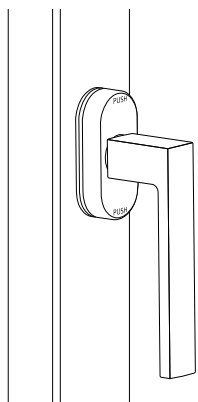

STEP 1/3

STEP 2/3

STEP 3/3

Tutti i diritti sono riservati. È vietata la riproduzione integrale o parziale e la diffusione dei contenuti di questo catalogo (siano essi testi, immagini o disegni) senza la preventiva autorizzazione scritta, da richiedere al seguente indirizzo di posta elettronica: info@lineacali.it.

Le caratteristiche tecniche sono passibili di modifiche. Il formato elettronico (PDF) di questo catalogo è disponibile sul sito lineacali.it.

L'esperienza suggerisce che è praticamente impossibile pubblicare un catalogo privo di errori; saremo quindi grati ai lettori che vorranno segnalarceli scrivendo all'indirizzo di posta elettronica: info@lineacali.it.

All rights reserved. It is forbidden to reproduce, in part or in whole, and to circulate the contents of this catalogue (text, images and drawings) without prior written authorization, to be requested at the following email address: info@lineacali.it.

The technical characteristics are subject to modification. The electronic format (PDF) of this catalogue it's available on the lineacali.it website.

Experience has taught us that it is practically impossible to print a catalogue with no errors, we would therefore be grateful to any readers that wish to point any out to us at the address: info@lineacali.it.

crediti / credits

progetto grafico / graphic design

Zack Alberto Bondoni

impaginazione / layout

Studio Creativo Fantàsia

testi / copy

Zack Alberto Bondoni

foto / photo

Rinaldo Capra

Tiziano Reguzzi

ambientazioni / location

Hotel Vittoria (Brescia)

Palace Hotel Villa Cortine (Sirmione, BS)

Romantik Hotel Laurin (Salò, BS)

Studio Creativo Fantàsia (Roè Volciano, BS)

Villa Baiana (Monticelli Brusati, BS)

Villa La Vittoriana (Salò, BS)



STUDIO CREATIVO FANTÀSIA

Dove le idee spuntano come funghi!

studiofantasia.it

carta / paper

Il marchio FSC® identifica che questo catalogo è stato stampato su carta contenente legno proveniente da foreste gestite in maniera corretta e responsabile secondo rigorosi standard ambientali, sociali ed economici. La foresta di origine è stata controllata e valutata in maniera indipendente in conformità a questi standard (principi e criteri di buona gestione forestale), stabiliti ed approvati dal Forest Stewardship Council® a.c. tramite la partecipazione e il consenso delle parti interessate.

The FSC® label means the paper in this catalog has been made with wood coming from forests managed in a correct and responsible way, following strict environmental, social and economic standards. The forest of provenance has been controlled and evaluated independently in accordance with specific standards (principles and criteria of good forest management), established and approved by the Forest Stewardship Council® through the participation and consent of the interested parties.



lineacali.it

Ed. LC008/05>2
01/2020

Linea Calì s.r.l.
di Danilo Calì, Paolo Calì e Mario Facchetti

Via Comunale, 89/91 | 25079 Vobarno (BS) Italy
Tel. +39 0365 59 91 98 | info@lineacali.it